

Supplement to

**PHARMACEUTICAL
ENGINEERING**

2011



Facility of the Year Awards

CATEGORY WINNERS





Building a brand new facility is never easy. But it can be easier.

Building a new, state-of-the-art pharmaceutical or biotechnology facility is no mean feat. But when you can rely on an international team of highly experienced and totally committed specialists, it all becomes a lot easier.

We have designed and delivered facilities just like the one you're planning. We have made it easier for some of the biggest names in the business and we will make it easier for you too.

Visit www.pmgroupproject.com for more information and details of your nearest PM Group office.

Engineers
Architects
Project & Construction Managers
C&Q Specialists
Sustainability Consultants



Supplement to **PHARMACEUTICAL ENGINEERING®**



Cover Photographs

Photos courtesy of
MedImmune, LLC, Merck &
Co., Inc., Novartis Vaccines
and Diagnostics GmbH, Pfizer
Manufacturing Deutschland
GmbH, Pfizer Health AB, and
F. Hoffmann – La Roche Ltd.

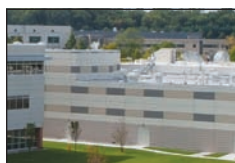

- 4 **2011 Facility of the Year Awards Program:
Best in their Class for the Benefit of Patients**
- Category Winner – Project Execution
- 8 **MedImmune, LLC**
Implementing Ordinary Tools in Extraordinary Ways
- Category Winner – Facility Integration
- 14 **Merck & Co., Inc.**
Maximizing Existing Infrastructure Expands Clinical Supplies Capability
- Category Winner – Equipment Innovation
- 20 **Novartis Vaccines and Diagnostics GmbH**
Innovative Equipment Design Increases Productivity
- Category Winner – Sustainability
- 26 **Pfizer Manufacturing Deutschland GmbH**
Engineering a Long Term Sustainability Program
- Category Winner – Operational Excellence
- 32 **Pfizer Health AB**
An Operation of Great Ingenuity
- Category Winner – Process Innovation
- 38 **F. Hoffmann – La Roche Ltd.**
Innovative Process Ensures Innovative Drug Delivery to Patients
- Honorable Mention
- 44 **Shire HGT**
Brave as the People they Help
- 46 **Interview with Chaz Calitri, 2011 FOYA Judging Panel Chair**
- 31 **Advertiser’s Index and Sponsors**

ISPE HEADQUARTERS
3109 W. Dr. Martin Luther King Jr. Blvd.
Suite 250
Tampa, Florida 33607 USA
Tel +1-813-960-2105
Fax +1-813-264-2816

ISPE ASIA PACIFIC OFFICE
73 Bukit Timah Road
#04-01 Rex House
Singapore 229832
Tel +65-6496-5502
Fax +65-6336-6449

ISPE CHINA OFFICE
Suite 2302, Wise Logic International Center
No. 66 North Shan Xi Road
Shanghai 200041, China
Tel +86-21-5116-0265
Fax +86-21-5116-0260

ISPE EUROPEAN OFFICE
Avenue de Tervueren, 300
1150 Brussels, Belgium
Tel +32-2-743-4422
Fax +32-2-743-1550

www.ISPE.org

Any reproduction of the contents
of this supplement in whole or
part is strictly forbidden without
the written permission of ISPE.
Views and conclusions expressed
in articles herein are those of the
authors and not necessarily those
of the editorial staff, officials and
Board of Directors of ISPE.

©2011 International Society for
Pharmaceutical Engineering.
Pharmaceutical Engineering and
the logo appearing throughout
this magazine are registered
trademarks.

2011 Facility of the Year Awards Program: Best in their Class for the Benefit of Patients

The Facility of the Year Awards (FOYA) program recognizes state-of-the-art pharmaceutical manufacturing projects that utilize new and innovative technologies to enhance the delivery of a quality project, as well as reduce the cost of producing high-quality medicines. Now in its seventh year, the awards program effectively spotlights the accomplishments, shared commitment, and dedication of individuals in companies worldwide to innovate and advance pharmaceutical manufacturing technology for the benefit of all global consumers.

“FOYA is a good venue to showcase excellence in engineering and allows companies an opportunity to discuss new and innovative ways to provide these services to our industry, which ultimately benefit our patients and communities,” said Jon Reed, Vice President, Engineering, Genentech, for Genentech’s ECP-1 Bacterial Manufacturing Facility, Overall Winner of the 2010 Facility of the Year Awards and member of the 2011 Facility of the Year Awards Judging Panel.

“Our organizations all benefit from learning about best in class methods or innovations around process design, sustainability, efficiency, and delivery innovations which drive better quality into our products, higher efficiencies in our production operations, and more cost effective ways to deliver our services.”

Six pharmaceutical manufactur-



MedImmune, LLC: centrifuge.



Merck & Co., Inc.: second level fluid bed dryer.

ing facilities constructed in Germany, Switzerland, Sweden, and the USA were selected as Category Winners in the seventh annual Facility of the Year Awards program sponsored by ISPE, INTERPHEX, and *Pharmaceutical Processing* magazine. A seventh facility was selected to receive an Honorable Mention. The winning companies and respective award categories are:

- **MedImmune, LLC**, winner of the Facility of the Year Award for *Project Execution* for its Frederick Manufacturing Center (FMC) Expansion facility in Frederick, Maryland, USA
- **Merck & Co., Inc.**, winner of the Facility of the Year Award for *Facility Integration* for its Global Clinical Supplies Manufacturing, Packaging and Warehouse expansion project in Summit, New Jersey, USA
- **Novartis Vaccines and Diagnostics GmbH**, winner of the Facility of the Year Award for *Equipment Innovation* for its “MARS Project” (Marburg Site) facility in Marburg, Germany
- **Pfizer Manufacturing Deutschland GmbH**, winner of the Facility of the Year Award for *Sustainability* for its SPRING and E-MAP (Strategic Plant Restructuring and Energy

Master Plan) project in Freiburg, Germany

- **Pfizer Health AB**, winner of the Facility of the Year Award for *Operational Excellence* for its Project Pegasus–Bio 7 Manufacturing facility in Strängnäs, Sweden
- **F. Hoffmann–La Roche Ltd**, winner of the Facility of the Year Award for *Process Innovation* for its “MyDose” Clinical Supply facility in Kaiser-augst, Switzerland
- **Shire HGT**, Facility of the Year Award *Honorable Mention* for its Project Atlas, Building 400 facility in Lexington, Massachusetts, USA

The Facility of the Year Awards program is truly global, as submissions over the past seven years have been received from more than 25 different countries and territories. Each of the submissions was reviewed by an independent, blue-ribbon judging panel consisting of global senior-level executives from all aspects of the industry. These industry professionals included:

- **Chaz Calitri, Judging Panel Chair**
Vice President, Global Engineering, Pfizer, Inc.



Novartis Vaccines and Diagnostics GmbH: segregation staging of equipment.

Concludes on page 6.

Fristam Ultraclean PD Pump



FKL-A Series
PD Pump

PD Pumps From the Experts You Trust

For decades, Fristam WFI and CIP-return pumps have been the industry standard for clean, reliable, and efficient processing.

The redesigned FKL-A positive displacement pump is built with traditional Fristam quality and manufactured of 316L stainless steel, for high performance and complete reliability. It is designed to provide consistent flow and gentle handling of shear sensitive products.

As with all Fristam pharmaceutical pumps and parts, the FKL-A is available with comprehensive documentation and comes with the best service and delivery time in the industry.

Contact Fristam, your trusted resource for pharmaceutical pumps, to learn more about the FKL-A positive displacement pump.

Designed to Meet Your High-Purity Needs

- Complete CIP and SIP cleanability
- Rounded, sterile exterior design
- Split-style gearbox for easy access to bearings and shafts
- Cartridge seals for easy replacement
- Industry experts who work with you to find the best solution
- Full documentation package
- Options include: equivalent port-to-port dimensions as other PD pumps, stainless steel gearbox, stainless steel rotors, high polish finishes, and Hastelloy and AL6XN



SEE US AT

INTERPHEX 2011[™]
Conference & Exhibition

Booth #2680

Fristam
PUMPS®

Engineered For Lasting Performance®

1.877.841.5001 | www.fristam.com/fkl



Pfizer Manufacturing Deutschland GmbH: quantum chilling unit.

- **Jim Breen**
Vice President, Project Management, Worldwide Engineering and Real Estate, Johnson and Johnson
- **Steve Dreamer**
Head of Global Pharma Engineering and Operational Excellence, Novartis Pharma AG
- **Brian H. Lange, P.E.**
Director, Quality Services, West Point Quality Operations, Merck & Co. Inc.
- **Geoff Monk**
Former Vice President, Global Engineering Services, Schering Plough
- **Shinichi Osada**
General Manager, Biopharm, Industrial and Logistics Systems Division, Hitachi Ltd.
- **Andy Skibo**
Senior Vice President, Global Engineering and Facilities, MedImmune
- **Ron Trudeau**
Vice President, Facilities Engineering Services, Baxter Healthcare
- **Jon Reed**
Vice President, Global Engineering, Genentech
- **Georgia Keresty**
President, Janssen Alzheimer Immunotherapy, Johnson and Johnson
- **Karen Kinney**
Director, Sustainable Facilities, LEED AP/Project Management and Engineering, BD

2011 Facility of the Year Events

There will be several opportunities to learn first-hand about the facilities being honored as “best in their class.” These events include:

- **INTERPHEX2011** – Meet the Category Award Winners from 29 to 31

March at the Facility of the Year Awards Display Area at booth number 1571 in the exhibit hall of the Jacob K. Javits Convention Center in New York City, New York, USA. This is your opportunity to meet personally with representatives from companies of the Category Winners to discuss the success stories associated with these pharmaceutical manufacturing facilities. To register or for more information, visit www.interphex.com.

- **ISPE 2011 Annual Meeting** – Hear presentations from the winning teams and learn first-hand who will win the coveted Overall Facility of the Year Award during ISPE’s 2011 Annual Meeting, 6 to 9 November in Grapevine, Texas, USA. For more information, visit www.ISPE.org.
- **Feature Articles** – Comprehensive coverage will appear in *Pharmaceutical Engineering* magazine and *Pharmaceutical Processing* magazine.

Visit www.facilityoftheyear.org for more information about the awards program and comprehensive details about each of this year’s award-winning projects and their support teams.

About ISPE

ISPE, the International Society for Pharmaceutical Engineering, is a Society of 22,000 pharmaceutical professionals in 90 countries who use expert knowledge to create high-quality, cost-effective GMP solutions. ISPE is “Connecting a World of Pharmaceutical Knowledge” by providing Members with opportunities to develop their technical knowledge, exchange practical experience within their community, enhance their professional skills,



Pfizer Health AB: buffer hold area.



F. Hoffmann – La Roche Ltd: Vartridge filling and closing unit.

and collaborate with global regulatory agencies and industry leaders. Founded in 1980, ISPE offers online learning opportunities for a global audience and has its worldwide headquarters in Tampa, Florida, USA; its European office in Brussels, Belgium; an Asia Pacific office in Singapore; and its newest office in Shanghai, China. Visit www.ISPE.org for additional Society news and information.

About INTERPHEX

Now in its 32nd year, INTERPHEX is the nexus for FDA regulated drug and drug delivery systems manufacturing for the pharmaceutical, biologic, generic, and contract services professionals. Scheduled for 29 to 31 March at the Jacob K. Javits Convention Center in New York City, New York, USA, the 2011 exhibition will feature more than 650 exhibitors, an expanded conference program, and a high-profile roster of industry professionals and speakers. For information, visit www.interphex.com.

About *Pharmaceutical Processing*

Pharmaceutical Processing magazine is the pharmaceutical industry’s leading information provider, reporting on a full range of innovative new products, equipment, technology, and trends for 28,000 engineers and managers responsible for the development, manufacture, validation, and packaging of pharmaceuticals. An official sponsor of INTERPHEX, *Pharmaceutical Processing* distributes critical information to these professionals in a timely manner through a full range of print, electronic and online media. For information, visit www.pharmpro.com. 

Fluor Congratulates MedImmune on its 2011 Facility of the Year Award for Project Execution

*MedImmune
Frederick Manufacturing Center Expansion
Frederick, Maryland, USA*



Award program sponsored by ISPE, INTERPHEX, and Pharmaceutical Processing magazine

FLUOR[®]

www.fluor.com

MedImmune, LLC

Implementing Ordinary Tools in Extraordinary Ways

Introduction

To enable production of forthcoming products, MedImmune built the **Frederick Manufacturing Center (FMC) Expansion** facility, winner of the **2011 Facility of the Year Award for Project Execution**. Located in Frederick, Maryland, USA, this complex and challenging project was delivered in an aggressive timeline with an outstanding safety record resulting in a facility capable of handling a wide range of product titers supported by a fully integrated Process Control System (PCS).

MedImmune implemented innovative strategies to assure project success. The project team used a military-inspired, four-tiered training methodology to help transition the workforce to the new facility. The team supplemented the training program with a comprehensive shakedown schedule that maximized practice runs prior to process validation. The team also developed a simulator that enabled them to execute commissioning and qualification of the PCS offline, freeing up physical equipment for shakedown runs. Despite an aggressive project schedule, the team successfully completed more than 13 shakedown runs and three process validation runs – without a single contamination or lost batch – concurrent to on-going construction work and Integrated Commissioning and Qualification (ICQ) efforts.

Project Overview

MedImmune currently has more than 100 biologics in research and development. The challenge of having a robust product pipeline is the operational capability and flexibility required to manufacture a diverse group of products with a wide range of titers.

To enable production of forthcoming products, MedImmune chose to build and license a flexible, large-scale mammalian cell culture-based production facility adjacent to MedImmune's



Exterior view.

existing Frederick Manufacturing Center (FMC), Building 636. The decision allowed the company to leverage the expertise and systems already in place at FMC, which had been used to successfully produce Synagis® (palivizumab) for the past 12 years.

The new facility, the FMC Expansion, Building 633, houses 337,000 square feet of administrative, production, warehouse, laboratory, and utility space. To accommodate future growth, MedImmune designed internal expansion capabilities of 100,000 square feet of production space. The new facility will be licensed for the manufacture of Synagis® by the US FDA.

MedImmune senior management set forth an aggressive project schedule with a forecasted timeline reduced by overlapping successive project phases. This approach increased the risk of impacting start-up activities, as delays in any one phase would cause a stacking effect of critical activities. Despite the aggressive schedule, the project was completed with an outstanding safety record of more than 2.3 million man-hours without a lost time incident.

MedImmune, LLC

Category Winner – Project Execution

Project: Frederick Manufacturing Center (FMC) Expansion facility

Location: Frederick, Maryland, USA

Project Mission: To build and license a large scale, mammalian cell culture-based manufacturing facility to support MedImmune's pipeline

Size: 337,000 sq. ft. (31,308 sq. m.)

Total Project Cost: \$588,389,000

Duration of Construction: 39 months

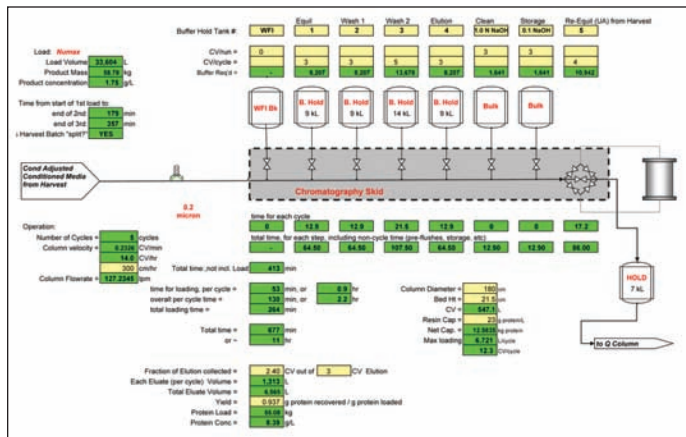

Process model.

Continued on page 10.



Chromatography solutions

optimized

for performance and productivity

Resolute® Columns for Process Scale

Resolute columns are ideally suited for process chromatography in the biopharmaceutical industry to reduce your manufacturing costs. Based on established and well-proven designs, Resolute columns provide improved column performance and true linear scalability combined with reproducible column packing methods for today's high performance media.

Complementary technologies include automated packing systems, slurry tanks, chromatography systems, tangential flow filtration systems, and single-use process technologies.

Put Resolute columns to work in your operations today.

W: www.pall.com/resolute

e: biopharm@pall.com

Congratulations
to MedImmune, LLC
2011 FOYA Winner
for Project Execution



Life Sciences

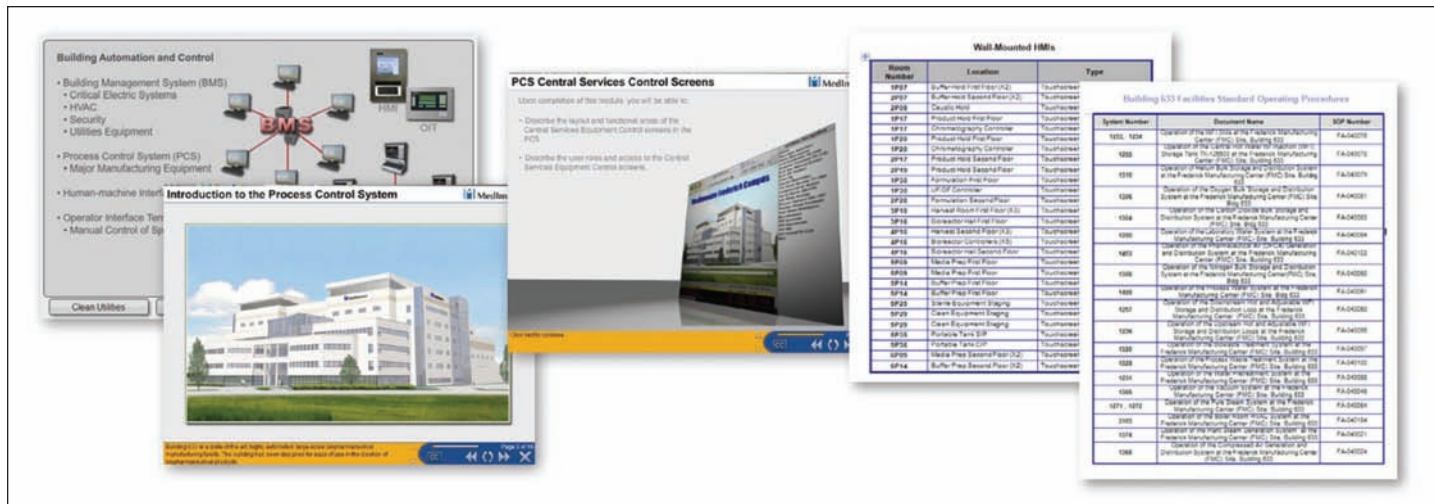

Concept training to gain a general understanding of how the facility and PCS would operate.

Military Training Methodology for Operations Training

The implementation of the automation system posed a complex challenge to the staff of the FMC Expansion, Building 633: by automating the manufacturing process, all procedures used to manufacture product would rely heavily on the PCS. This was a fundamental change from the manufacturing processes in the former production facility.

An audience analysis identified more than 100 staff members and an anticipated 100 additional manufacturing operators who would need detailed training on the use of this system, specific to their job function. The strongest requirement for training these audiences was to change their daily behavior from operation of a small-scale, semi-automatic manufacturing facility to a fully-automated, multi-product facility with a scaled up production volume, without risking equipment damage to any critical process and support systems or risking loss of product materials due to incorrect use of the PCS.

The MedImmune team designed a four-tiered, blended learning approach, commonly used in military training, but rarely implemented in the biopharmaceutical industry. This training

continuum was based upon theories of adult learning and created to allow self-paced, discovery-based knowledge transfer to existing staff and new-hires. Components of this continuum included concept training; review of operational SOPs; hands-on, instructor-led training; and a comprehensive, plant-wide controls simulator for ICQ and operator training.

Concept Training

Concept training consisted of interactive computer based training, which allowed employees to gain a general understanding of how the facility and the Process Control System (PCS) would operate, followed by review of Standard Operating Procedures (SOPs), specific to their job function.

Review of Operational SOPs

The second module in this training continuum involved the requirement of students to obtain operational SOPs from MedImmune's electronic Document Management System and review the SOPs as preparation prior to attending hands-on training.



Part of the dedicated training lab.

Notes from the Judging Panel – What Impressed Them

- *Excellent safety record: 2,300,000 man-hours without a lost time incident.*
- *The focused and thoughtful effort to help the workforce transition related to project execution was impressive.*
- *Overall, it was a complex and challenging project that was delivered in an aggressive timeline and with an outstanding safety record.*
- *The need to achieve flexibility in process at such a scale required MedImmune to overlap project phases, greatly increasing risk to the project.*
- *Use of Military Training Methodology that resulted in the successful shakedown runs and process validation runs performed concurrent to on-going construction and ICQ activities*

Award Category – Project Execution

Winners in this category exemplify the application of novel tools and approaches to delivering projects that improved efficiencies, overcame unusual challenges, promoted effectiveness, and organized stakeholders and project team participants in ways that led to successful outcomes.

Hands-On, Instructor-Led Training

A dedicated training lab was built by creating a pared-down version of the PCS. The lab included a subset of the control

functionality on the manufacturing floor. The lab allowed operators to train on a “live” system that looked, felt, and behaved like the real PCS. A series of instructor-led sessions which

Why Our Project Should Win

The following is an excerpt from MedImmune’s submission, stating in their own words, the top reasons why their project should win the 2011 Facility of the Year Award:

Exceptional Product Titer Range Capability of 7.0g/L (14x)

- To accommodate the manufacture of future products, we designed Building 633 as a flexible facility with a product titer range of 0.5 to 7.0 grams per liter. Though a 10x process range has been achieved in practice before, we believe that Building 633 is the first large-scale facility in the industry able to produce a 14x process range up to 7.0 grams per liter.

Extraordinary Methods to Implement one of the Largest Process Control Systems in the Industry

- We planned for a modular approach to integration and engaged all equipment skid manufacturers early in the PCS development process. We distributed the S88 model to the skid manufacturers to ensure development of common equipment and control modules. To verify that these skids would flawlessly integrate into our PCS infrastructure, we developed a FATPAC. The FATPAC is a portable package of servers that replicated our high-level process network and allowed us to test the equipment in our environment, at each vendor site.

Complete Replication of Process Control System for Offline ICQ and Operator Training

- We developed a complete, isolated replica of the Process Control System to allow validation activities to be

performed at the same time as equipment validation and shakedown, to reduce risk. Replication of the manufacturing equipment operation, using PLC controllers in a virtual environment, proved to be an efficient and effective method for PCS validation.

Military Training Methodology for Successful Operational Training

- Our blended, four-tiered approach to development and delivery of PCS training enabled manufacturing operators to successfully use the automated Process Control System. By focusing on real-world training scenarios, state of the art simulators, and a hands-on approach, we quickly transferred critical knowledge to key personnel to support start-up activities.

Unique, Progressive, and Successful Shakedown and Process Validation Methodology

- We planned for successive shakedown runs several years before the start of qualification and planned other activities with support of shakedown as a top goal. Shakedown activities, which commenced during commissioning and qualification, were planned early on and took precedence in the project schedule. This approach maximized operator on the job training, as well as opportunities to identify issues. The shakedown phases were designed to progressively use equipment through the manufacturing process. We successfully ran 13 shakedown runs and three PV runs without a single contamination or lost batch.

Concludes on page 12.

mirrored actual production scenarios also were created. These sessions allowed operators to use the PCS Human-Machine Interfaces (HMIs) to perform tasks, such as media preparation, transfer operations, and cell culture, harvest, and purification operations. Operators were provided the opportunity to learn in a safe environment where they could not harm themselves, others, or equipment.

Comprehensive, Plant-Wide Controls Simulator for ICQ and Operator Training

The project team understood that proficiency on the live system would require additional practice using the PCS. In order to not risk the loss of knowledge between the times the operators trained and when they used the live PCS and to assist in ICQ activities, the project team developed a PCS simulator for all operators who had completed the instructor-led training in ICQ activities. Use of this simulator helped ensure proper use of equipment through the PCS.

Shakedown and Process Validation Methodology

The project team needed to allow operators a significant amount of on-the-job training before the start of Process Validation (PV) runs to ensure the effectiveness of the training strategy. In ad-

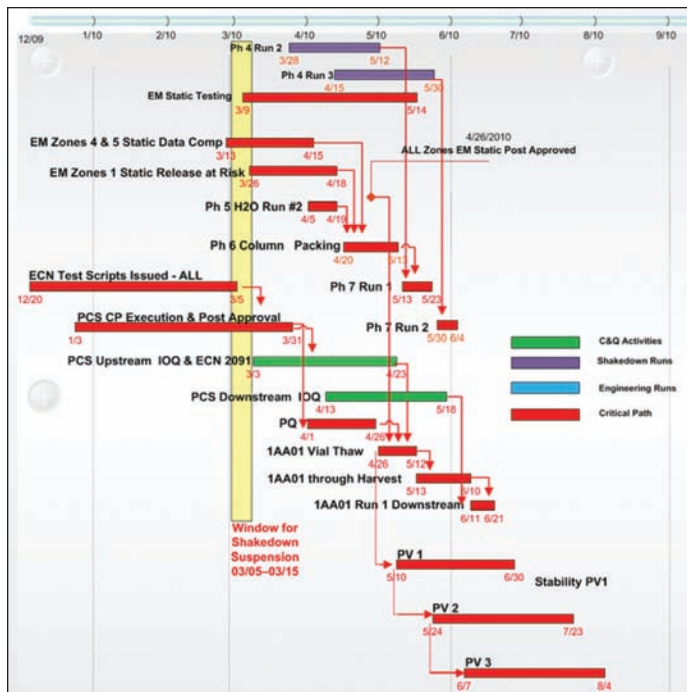

Integrated shakedown methodology.

Key Project Participants

Engineer: Parsons Commercial Technology Group (Boston, Massachusetts, USA)

Construction Managers:

- Fluor Enterprises Inc (Greenville, South Carolina, USA)
(See ad on page 7)
- Parsons Commercial Technology Group (Boston, Massachusetts, USA)

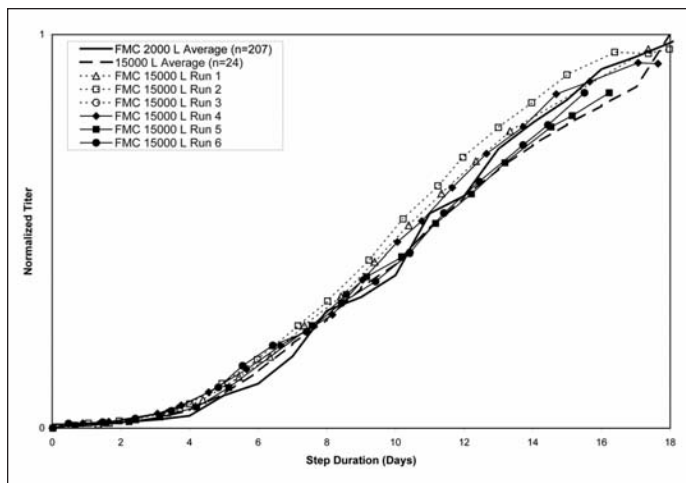

Process data from shakedown runs.

dition, the team needed a great deal of experience running the processes within the facility to find potential issues.

To meet these challenges, the team ran progressive shakedown runs within the facility over an extended period of time to discover potential operational difficulties. Each shakedown run phase utilized more equipment than the previous phase and started concurrently with ICQ activities. The shakedown phases separated unit operations to allow for complications, problem-resolution, and lost batches, and gain experience particular to each unit operation.

As the shakedown activities took precedence in the schedule, it was necessary for the project team to perform activities related to the commissioning and qualification of the PCS in parallel without interrupting shakedown runs. The PCS simulator allowed the project team to commission and qualify major aspects of the PCS without having to perform work on the plant floor. The system, which simulated every Programmable Logic Controller (PLC) in the facility, provided a safe, equivalent environment to perform testing.

Conclusion

The project team achieved its goals by implementing ordinary tools in extraordinary ways. Its innovative approach to startup and operator training, its process for offline validation, and robust project management processes allowed it to overcome many potential problems.

The project team completed more than 13 shakedown runs and three PV runs and did so concurrent to on-going construction work and intense commissioning and qualification efforts. The final three shakedown runs were complete runs that were fully representative of the process. From the start of manufacturing in the facility, the product met all established process benchmarks at both medium and large scale without a single contamination or lost batch.

In the end, solid planning, innovative problem resolution, and fast-paced but efficient execution allowed MedImmune to build and validate a world-class, flexible manufacturing facility with a state of the art automation system. 

TECHNISERV, INC.

351 South Eaton Street, Berwick, PA 18603

Ph. 570-759-2315

www.techniservinc.com

Bioreactor & Fermentation Suites Including upstream & downstream processing equipment



Techniserv is one of a very few U.S. based Design – Build suppliers of the critical process systems producing licensed products. Several of the largest FDA regulated GMP biopharmaceutical manufacturers utilize process suites including the entire range of Techniserv process equipment skids.

Process Engineering Services

In addition to providing Design - Build systems for therapeutic, vaccine and API production, Techniserv also offers Process Engineering Services as a standalone activity or in conjunction with a process equipment order. A partial list of services includes:

- Basic and Detailed design of processes and equipment
- Utility sizing
- CFD modeling & evaluation of new / existing agitation requirements
- Heat, gas and mass transport modeling of bioreactors / fermentors
- Equipment sizing for separation, filtration and purification steps
- Detailed SIP and CIP design for in-suite equipment and piping
- Facility process equipment audits

Techniserv invites anyone with a new or identified process requirement to contact one of our representatives or, to learn more about us on the web, visit us at

www.techniservinc.com.

Contacts:

Paul Heaps II — Michael Smith — Brandon Kotsko



Harvest, UF & MF
Module

TECHNISERV, INC.
Congratulates MedImmune, LLC in their
outstanding achievement.

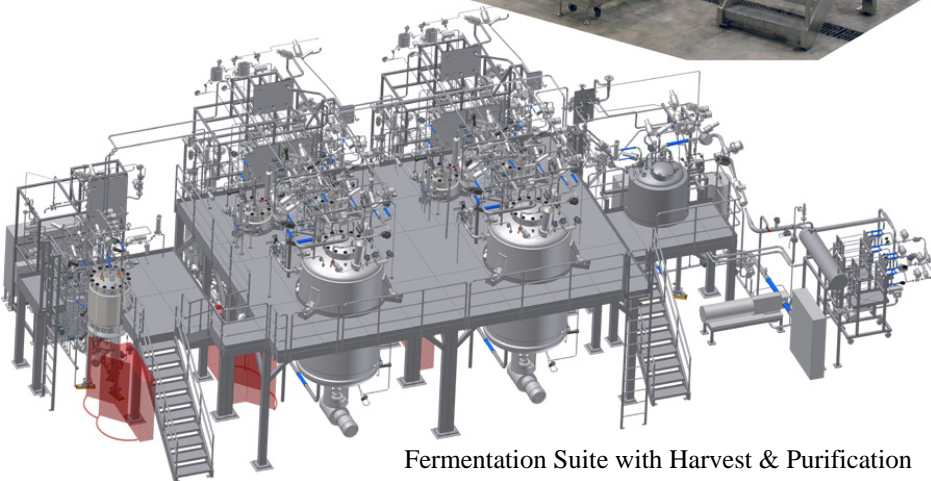

Fermentation Suite with Harvest & Purification



Merck & Co., Inc.

Maximizing Existing Infrastructure Expands Clinical Supplies Capability

Introduction

Merck & Co., Inc. was on a mission to expand, enhance, and integrate its core drug product development, manufacturing, and packaging capabilities. Part of that mission was to meet a strategic need to increase productivity, efficiently manage a significant increase in clinical trial patient demand, and create a facility capable of supporting both conventional and potent compounds.

To accomplish these goals, Merck & Co., Inc. embarked on the **Global Clinical Supplies Manufacturing, Packaging and Warehouse Expansion** project, which consolidated several cGMP clinical manufacturing, packaging, and warehouse areas within a single state of the art facility in Summit, New Jersey, USA. Deemed by the judging panel as truly representative of its category, the project is winner of the **2011 Facility of the Year Award for Facility Integration**.

The project team employed a parallel, three-phased “hybrid-build” approach, integrating greenfield, modular, and stick-built construction. The team used an existing decommissioned production building, partially demolishing, renovating, and adapting the structure for improved clinical manufacturing and development.

Merck & Co., Inc.

Category Winner – Facility Integration

Project: Global Clinical Supplies Manufacturing, Packaging, and Warehouse Expansion

Location: Summit, New Jersey, USA

Project Mission: To expand and improve core drug development capabilities, meet the strategic need to increase productivity, and efficiently manage a significant increase in clinical trial patient demand. Create a facility with the ability to achieve 10ug/m³ over an 8-hour time weighed average, thus introducing engineering controls to limit possible exposure and reducing reliance on personal protective equipment.

Size: 240,666 sq. ft. (22,359 sq. m.)

Total Project Cost: \$216,000,000

Duration of Construction: 24 months



Exterior view.

Response to a Business Plan

Merck & Co., Inc. needed to support their growing product development pipeline. Their Global Clinical Supplies units were operating in several locations in New Jersey with limited space, equipment capability, and scale. Third party organizations were being utilized for portions of the clinical manufacturing process. Due to these limitations, meeting the growing pipeline needs was difficult. In addition, the mix of potential compounds in the pipeline indicated a need for a flexible, multi-product solution to manufacture and distribute clinical supplies.

An existing building was selected to support drug development in the stage between discovery and commercialization where products for clinical trials are manufactured along with the new technologies developed for transfer to commercial production facilities.

The most cost effective solution was to renovate and expand the selected site into a single, state of the art facility capable of producing all types of dosage forms, including tablets, capsules, non-sterile liquids, and inhalation products.



Exterior of clinical manufacturing operations.

Continued on page 16.

Congratulations, Merck & Co., Inc.

Facility of the Year - Facility Integration

**Global Clinical Supplies
Manufacturing, Packaging and
Warehouse Expansion**

Summit, NJ



IPS Booth #1579

Facility of the Year Display Area #1571

**Engineering • Construction
Commissioning & Qualification**

Facility of the Year



www.ipsdb.com

Project Overview

The project consolidated clinical manufacturing, packaging, and warehouse areas within 240,666 square feet of state of the art facilities at the Summit, New Jersey site. A successful three-phased “hybrid-build” approach was employed, including utilization of modular construction for primary manufacturing operations; adaptive reuse of a former pharmaceutical warehouse; new construction of an Operations Support Building; and a parallel site utility project and solar install. Upon completion, the team met aggressive deadlines with minimal site and environmental disruption and maximized utilization of existing infrastructure.

The clinical manufacturing facility was constructed by Pharmadule modular fabrication in Sweden. Related equipment and utilities were installed during fabrication and integrated into each module, thereby reducing time and enabling concurrent



Module fit-out in Sweden.

engineering project completion in Sweden. At the same time in New Jersey, demolition, excavation, and foundation work was

Why Our Project Should Win

The following is an excerpt from Merck & Co., Inc.’s submission, stating in their own words, the top reasons why their project should win the 2011 Facility of the Year Award:

Factors for winning revolved around the fact that diverse and complex technical user requirements involving the design of GMP clinical supply and development facility to support existing and future manufacturing technologies supports an existing and projected new chemical entity development portfolio over the next 15+ years.

- **State of the art, flexible GMP facility** was designed and constructed for present/future growth to meet the strategic need for increased capacity, capability, productivity, and efficiency.
- **Outstanding project execution, integrated, multi-phased “hybrid-build” design/construction approach:**
 - partial demolition of a decommissioned commercial production facility
 - adaptive reuse of former pharmaceutical warehouse as part of overall facility
 - utilization of modular fabrication/construction for primary manufacturing functions
 - “stick-built” three-floor Operations Support Building (OSB)
- Integrated, well coordinated, and collaborative **project management** approach utilizing **complex front-end planning, outstanding integration** of several **high performance** project teams, including communication and collaboration, was key for successful on time, on budget project completion. An EU inspection team provided input throughout the design and construction phases. **Multiple safety teams** were an integral part of all project teams from project inception.
- Co-located (three sites in Sweden/four sites in the US) project teams utilized a customized, **web-based Project Information Management System (PIMS)** to develop, re-

view, monitor, control, document, and archive **key aspects** of the design, construction, qualification, schedule, and costs.

- **Innovative integration** of overall manufacturing strategy with scalable design to support development of a **variety of products**, including oral solid dosage, liquid, and inhalation products – for early and late stage clinical manufacturing – packaging and process development.
- Ability to achieve 10ug/m³ over an 8-hour time weighed average, thus introducing engineering controls to **reduce possible exposure** and **reducing reliance** on personal protective equipment.
- **Integrated functionality** supporting material and personnel flow from raw material storage and dispensing through manufacture and clinical packaging, including drug product GMP ICH guideline stability storage and staging
- Process technology platforms included a **combination of portable and fixed process equipment**.
- Incorporates **innovative technologies** and facility controls for solid oral and potent compound containment to promote **safety, quality, and compliance**.
- **Innovative redesign** solution of modular building support piers originally to be cast in place prior to setting the modules. By pre-casting the piers, a smaller, 300-ton crane was able to move throughout the modular building footprint enabling the pre-cast piers to be moved into place and bolted down as needed. Installation of the building modules continued **uninterrupted** and in a **very cost effective** approach.
- **Cutting edge data gathering** system incorporating both building management and process control capabilities within the **same platform**, while utilizing non-proprietary commercially available software allowing for ease of modification.
- Multiple integrated risk assessment and HAZOP reviews to **promote safety** and enabled the team to **engineer out known issues**.

Notes from the Judging Panel – What Impressed Them

- *The project was very well done from a facility integration perspective as the project is truly representative of the category definition for Facility Integration.*
- *Good integration of greenfield, modular, and renovated facilities to satisfy the project requirements.*
- *Good utilization of a “hybrid” construction approach that enabled Merck & Co., Inc. to achieve an aggressive timeline while making use of existing facilities, resulting in a facility that is flexible with integrated functionality.*
- *The “hybrid” approach was more cost effective compared to conventional options and enabled Merck & Co., Inc. to maximize reuse of the existing infrastructure.*

Award Category – Facility Integration

Winners in this category exemplify the application of good design practices and superior conceptual planning which led to excellent integration of facility and process, yielding efficient, clean, pleasant environments promoting business advantages for staff and enterprise, encouraging excellent processing outcomes. Synergistic merging of process and building to create environment of form and functional excellence.

ongoing. When the modules arrived, they were set, assembled, and “hooked” up.

Parallel, Three-Phased “Hybrid-build” Approach

As part of a three-phased “hybrid-build” approach designed to accelerate the timeline, the project team was dispersed geographically on three concurrent multi-project phases guided by a Merck & Co., Inc.-driven master schedule. Key to this approach was well-coordinated project management with a high level of front-end planning and constant communication.

To further complicate matters, an existing adjacent Solutions Distributions Center had to remain fully operational during all phases of the project and required extensive pre-planning, automation and sensitivity testing, simulation vibration and

measuring impact. In addition, the existing Summit campus is an active site with high levels of site traffic; this continued during all three phases of the project. Careful consideration and a high level of pre-planning from all project teams was given to the people and material flow plans along with extensive planning of the transportation of the modules from Sweden and the setting of the modules in the city of Summit, New Jersey.

Site preparation included the demolition of portions of the former pharmaceutical manufacturing and warehouse structure, clearing, grading, and site utility upgrades. Work also included modification and tie-in to existing underground utilities and coordination with site utility projects (chiller and solar installation) to support the new operations.

A very significant element of the site preparation was the construction of the modular building process and manufactur-



Modular site unique foundation and piers.



Module fabrication.

Concludes on page 18.



Stick-built mechanical mezzanine.

ing foundations. These were constructed to a +2 mm tolerance in preparation for receipt of the modules. A portion of the foundation piers also were designed to be removable in order to allow a more efficient and lower cost rigging approach. As the modules were rigged into place, the crane worked its way out of the foundation area and removable piers were set for the balance of module setting.

Modular Fabrication and Assembly (50,000 sq. ft./4,647 sq. m.)

This phase included fabrication of 82 modules in Sweden; transport to the Summit site; and installation and assembly of the modular process and manufacturing building, including all related process equipment, clean utilities, HVAC, and building equipment. The facility, equipment, and utilities were commissioned and validated. Utilizing a portion of an existing structure and fabrication construction, the completed two-story structure now contains clinical scale manufacturing and processing operations, including oral solid and non-sterile liquids and inhalation products production.

Key Project Participants

Architect: Jacobs/Wyper Architects, LLP (Philadelphia, Pennsylvania, USA)

Design Manager/Engineer: Integrated Project Services (IPS) (Somerset, New Jersey, USA) *(See ad on page 15)*

Construction Manager: Skanska USA Building Inc. (Parsippany, New Jersey, USA) *(See ad on page 19)*

Modular Design/Fabrication: Pharmadule, Inc. (Bedminster, New Jersey, USA)

Stick-Built Renovation (80,000 sq. ft./7,432 sq. m.)

The remaining areas of the existing building were renovated back to the basic structure with roof membrane and insulation removal and replacement. This phase included retrofit of the existing building to accommodate shipping and receiving, warehousing, primary and secondary clinical packaging, dispensing, stability, locker rooms, laboratories, calibration, process equipment maintenance, utility, mechanical and support areas. Electrical substations and other building utilities were designed and installed to support the renovation, modular manufacturing, and the Operations Support Building. Construction was completed for a new structural mezzanine within the existing warehouse to house mechanical and electrical equipment and to provide access to the second floor of the modular building. The facility, equipment, and utilities were commissioned and validated.

Greenfield Construction (90,000 sq. ft./8,736 sq. m.)

This phase included construction of the new Operations Support Building (OSB), a three-story building connected to manufacturing operations via an enclosed walkway. Approximately 40% of the OSB third floor was left as a shell for future expansion. The facility and utilities were commissioned and validated.

Conclusion

Utilizing the “hybrid-build” approach enabled Merck & Co., Inc. to achieve an aggressive timeline while making use of existing facilities and minimizing site disruptions. The outcome was a facility that is flexible with integrated functionality. The approach also proved to be cost-effective compared to more conventional options, as Merck & Co., Inc. was able to maximize reuse of existing infrastructure. 

Worldwide Resources. Local Expertise.

Providing the best healthcare in the future means building the best pharmaceutical research and manufacturing facilities today. Skanska is dedicated to providing innovative solutions and leading-edge technology for our life sciences clients. Through close collaboration and performance excellence, we deliver something our competitors can't – certainty of outcome.

As proud partners of ISPE Facility of the Year award-winning projects, we congratulate Merck and Pfizer Health AB on their continued success.

Facility Integration
Merck

Operational Excellence
Pfizer Health AB

When you are looking to build the facility of tomorrow, build with Skanska today.



SKANSKA

www.usa.skanska.com

Novartis Vaccines and Diagnostics GmbH

Innovative Equipment Design Increases Productivity

Introduction

The Novartis Vaccines' **MARburg Site (MARS)**, located in Marburg, Germany is intended to satisfy future potential growth in vaccine production volumes driven by healthcare and market demands, current and future GMP and regulatory requirements, requirements for state of the art facilities, and efficiency and productivity improvements.

Winner of the **2011 Facility of the Year Award for Equipment Innovation**, the facility produces vaccines for Rabies and Tick Borne Encephalitis (TBE). The project impressed the judges in several respects, most notably the facility's Laser Egg Opener or LEO, a system capable of handling 3,000 eggs per hour. The system eliminates the potential for cross contamination compared with traditional contact methods and increases process throughput, resulting in a tenfold productivity increase for Novartis.

Project Overview

The MARS project integrates onto one site the manufacture of existing vaccine concentrates and the production of media, buffer, and adjuvant products. It also integrates support function, for example, by centralizing the equipment cleaning and sterilization facilities for the Marburg site and beyond. The MARS project also provides a new state of the art Quality Control Building that consolidates the analytical and other QC functions.

The production facility is capable of manufacturing 20 million doses of Rabies vaccine or 40 million doses of TBE vaccine or any combination utilizing two interchangeable production lines. The media, adjuvants, and buffers production supports all of the 20 vaccines (registered in more than 80 countries worldwide) within the Novartis portfolio.

The QC facility typically performs 35,000 to 40,000 analytical tests and more than 100,000 environmental and utility monitoring samples per annum.

Novartis Vaccines and Diagnostics GmbH

Category Winner – Equipment Innovation

Project: MARburg Site (MARS)

Location: Marburg, Germany

Project Mission: A strategic investment to satisfy future potential growth volumes and current and future GMP and regulatory requirements

Size: 257,042 sq. ft. (23,880 sq. m.)

Total Project Cost: \$242,000,000

Duration of Construction: 18 months



Aerial view.

The warehouse is an integral part of the production facility, ensuring lean raw material and final product movement via a connecting spine. It has a capacity of 4,000 pallet spaces with chilled and ambient temperature storage.

The power plant and utilities ensure that the facility is independently supplied with utilities.

A New Process Flow

The design leverages the revised requirements for live vaccine processing issued by the US FDA in October 2007 and made effective in July 2008. The unique facility design and operating concept allows concurrent manufacturing of two different live vaccines on two segregated manufacturing lines in the same production area. The changeover procedure allows the switch of manufacturing from one vaccine to another. In other words, there is full flexibility to manufacture two vaccines either con-



QC facility.

Notes from the Judging Panel – What Impressed Them

- *Fast-track execution in only 26 months.*
- *Excellent safety record: 1.7 million man-hours with no LTI.*
- *Flexibility allowed for concurrent production of two live viruses.*
- *The Laser Egg Opener is capable of 3,000 eggs per hour and the system eliminates cross contamination and increases process throughput that resulted in a 10-fold productivity increase.*

currently or in campaign. This inherent flexibility allows the facility to respond fast to public health and market needs and reduce the cost of running dedicated facilities.

Cell Preparation

The upstream of the process is based on the infection of a suspension of chicken embryos fibroblasts with live virus. The cells and the viruses are incubated at controlled temperature for five days in single use cell factories and the virus suspension is harvested into a fixed stainless steel vessel.

Virus Propagation

The harvest is filtered in a second vessel in which the inactivation agent is added to the harvest and mixed. To complete the inactivation, a maturation step takes place in a third vessel.

Inactivation

A purification/concentration step by ultracentrifugation on sucrose gradients completes the process. The transfer between vessels to the ultracentrifuges is with stainless steel lines. From the harvest vessel to the ultracentrifuge, the biosafety and sterility of the product is ensured by a closed system. All transfers are driven by the automation system. Transfer lines and vessels



Fixed mixing inactivation and maturation vessels.

Continued on page 22.



Congratulations Novartis Vaccines and Diagnostics GmbH

Winner of the 2011 Facility of the Year
Award for Equipment Innovation



M+W Process Industries GmbH takes pride in its partnership with Novartis Vaccines and Diagnostics GmbH. An exceptional team collaborated in delivering cutting edge technology design as well as fast-track execution.

Integrated Solutions and Services for the Process Industry

Consulting | Engineering | Procurement |
Architecture | Construction Management |
Qualification | Validation | Technical Facility
Management | Design & Build | Turnkey |

M+W Process Industries GmbH

A Company of the M+W Group
(Headquarters)
Lotterbergstr. 30, 70499 Stuttgart
Germany
Phone +49 711 8804-1800
Fax +49 711 8804-1888
info.pi@mwgroup.net
www.pi.mwgroup.net



M+W GROUP



Facility hallway.

are sterilized with clean steam (SIP), cleaning in place (CIP) by units dedicated to each of the two manufacturing lines.

Lean and Clean Layout

The layout of the process flow is not only LEAN, but also accommodates the manufacturing of sterile inactivated virus suspension concentrate and a production suite ensuring biosafety Level 3 containment for the upstream steps of the virus production.

To avoid potential conflicts between GMP and biosafety, the cleanroom classification and air pressure regimes ensure that the correct air quality and airflow direction maintains the overall integrity of the facility. At the same time, biosafety Level 3 is achieved and cross contamination avoided, accommodating GMP and biosafety requirements. To efficiently manage the risk of personnel carrying virus particles in the surrounding corridor, an airshower has been installed between the sink airlock within the biosafety boundary and the bubble airlock in the surrounding corridor. The airshower acts as a containment cabin with interlocked airtight doors in which HEPA filtered air is circulated at high speed. This device is typically used to access cleanrooms from unclassified areas. In this design, it is used as a measure to avoid potential cross contamination.

The manufacturing suites are completely independent from each other with process step segregation for each stage of manufacturing. The lines are composed of a cell preparation suite, a

virus propagation suite, an inactivation maturation suite, and an ultracentrifugation suite.

The central clean corridor separates the two manufacturing lines ensuring no cross contamination. This corridor allows movement of clean/sterile materials, consumables, and reagents to the manufacturing suites through unidirectional material airlocks. The airlocks prevent process cross contaminant in the corridor and ensures no impact on the batches manufactured on the second line.

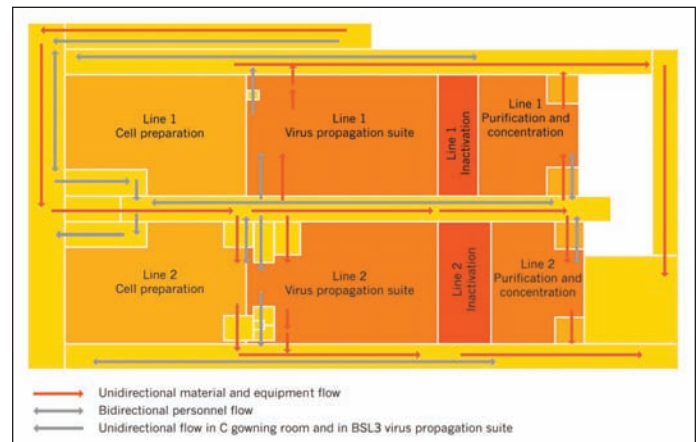

Manufacturing suite layout.

Why Our Project Should Win

The following is an excerpt from Novartis' submission, stating in their own words, the top reasons why their project should win the 2011 Facility of the Year Award:

- The facility uniquely combines from original concept design the concurrent production of two live viruses to produce inactivated vaccine concentrates. This inherent flexibility allows the facility to respond fast to public health and market needs and reduce the cost of running dedicated facilities.
- The design of the production facility is based on the full integration of the raw material, receipt flow into the manufacturing area through to the warehouse in a single controlled environment (via connecting spine). The incorporation of lean process flow enables the optimization of manufacturing costs and increased throughput contribution to a 10-fold improvement. Scale up and integration of the new centralized washing facility is a true example of equipment innovation within the facility. The QC facility is planned with high flexibility of space to suit the rapidly changing needs of the vaccine business. Its unique features rely on its potential to realize fast adaptation. This

is achieved while maintaining the Bio-Safety Level 2 and 3 integrity essential to performing viral safety testing.

- In the MARS facility, the process of opening eggs is performed using an industrial scale laser process to eliminate cross contamination. This equipment is one of the largest applications of this type of technology and represents the combination of accurate manipulation, laminar flow control (aseptic conditions), and laser cutting to achieve 3,000 eggs opened per hour.
- The unique application of "PENTA-GEN" technology is a smart mix between conventional and state of the art generation providing five energies: electrical power, emergency power, hot water, steam, and chilled water. This combination achieves the highest efficiency representing a 12.755/year reduction of CO₂ (60% reduction compared to industrial park supply).
- The project execution truly achieved a balance of highest quality, optimum cost within a schedule compared with the best of fast track examples. During its project execution, the business and team in Marburg also responded positively to a public healthcare challenge caused by the 2009 H1N1 pandemic.

Concludes on page 24.



Exam Dates

7 March – 1 June 2011

6 September – 14 October 2011

Becoming a CPIP™

The journey to becoming a CPIP™ can go at the pace you desire. Eligibility applications are accepted at any time and exam dates occur twice a year.

Available Resources

ISPE-PCC has a downloadable Study Guide available to assist candidates in preparing for the examination. ISPE Training offers CPIP™ Online Learning Courses as well.

To find out more, visit the ISPE Professional Certification Commission (PCC) website at www.ISPE-PCC.org

www.ISPE-PCC.org





Eggs opened using an industrial scale laser process.

Award Category – Equipment Innovation

Winners in this category exemplify the novel application of commercially available and custom developed process manufacturing and facility management tools, which yielded superior results, advanced processing understanding, and improved competitive position. Includes imaginative collaboration with vendors/suppliers/manufacturers.

Laser Egg Opening: Eliminating Cross Contamination

The production of Rabies and TBE vaccines consists of three major production steps: 1) preparation of the cell suspension, 2) virus propagation, and 3) concentration of the inactivated virus.

In the first step of production, eggs are used to produce cells for the next steps in the production flow. In the new MARS facility, the process of opening eggs is performed using an industrial scale laser process under strict cleanroom conditions. The Laser Egg Opener (LEO) automatically opens eggs in parallel while maintaining aseptic conditions.

Within the new LEO handling system in the MARS facility, the pre-disinfected eggs are handled on trays with capacity for 84 eggs with potential to accommodate 3,000 eggs/hour. The trays are manipulated by the operator at the front end of the laser egg opener within a laminar flow tent. Transportation of the eggs through the egg opener is by means of a conveyor belt system controlled by optical sensors. These can detect tray position and occupation. This ensures that the laser is only distributed to the eggs present and not to the empty spaces. The layout of the trays and the conveyor system allows the opening of four eggs in parallel using four individual laser beams.

In the past, the opening of the eggs was performed manually with the help of an “egg puncher” device, which operated

pneumatically. The operator had to manually open every single egg with this device. This method, carried out under cleanroom classification C, increased the risk of cross contamination due to the contact and damage to the eggs.

The LEO system eliminates the potential for cross contamination and increases process throughput, resulting in a tenfold productivity increase for Novartis.

Conclusion

The MARS facilities are the pillars of the Center of Excellence for modern vaccines production at Novartis in Germany. As demonstrated by the LEO system, the project represents Novartis’ strategic investment in its global vaccines manufacturing capabilities, providing an opportunity to: enhance LEAN manufacturing techniques, innovate processes, improve efficiency and productivity, and reduce the costs of producing high-quality medicines. 

Key Project Participants

Engineers:

- Production: M + W Process Industries (Stuttgart, Germany)
(See ad on page 21)
- Warehouse: Miebach Consulting GmbH (Frankfurt, Germany)
- Quality Control: Labotech Planungs GmbH (Griesheim, Germany)
- Power Plant: Pöyry GWK GmbH (Erfurt, Germany)



Laser egg opener.

Featured ISPE Guidance Documents

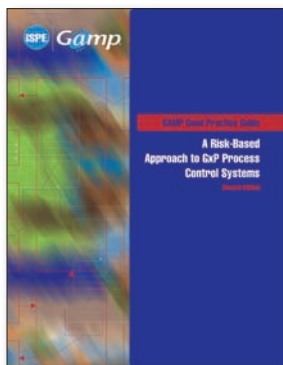

GAMP® Good Practice Guide: A Risk-Based Approach to GxP Process Control Systems (Second Edition)

This Guide is a revision of the *GAMP® Good Practice Guide: Validation of Process Control Systems*. It aims to achieve process control systems that are fit for intended use and compliant with applicable regulations; providing recommended good practice based on a life cycle approach for the development, maintenance, and management of process control systems.

The Guide applies science-based Quality Risk Management, as described in ICH Q9 and GAMP 5. It describes the system life cycle from concept to retirement, providing a high level overview of the approach together with guidance on how activities might be scaled based on risk to product quality, system novelty, and complexity as well as other project specific factors.

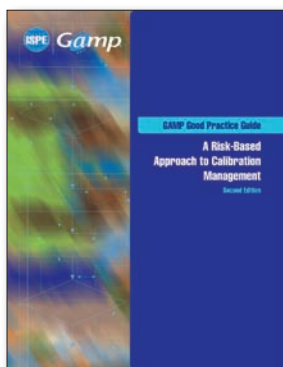

GAMP Good Practice Guide: A Risk-Based Approach to Calibration Management (Second Edition)

The *GAMP Good Practice Guide: A Risk-Based Approach to Calibration Management (Second Edition)* provides guidance in setting up a calibration management system, which will give a structured approach to instrument risk assessment, calibration program management, documentation, and corrective actions, essential to regulatory compliance. The Guide has been updated to address the changing environment, while still satisfying international GxP regulatory expectations.



ISPE Product Quality Lifecycle Implementation (PQLI) Guide: Overview of Product Design, Development, and Realization: A Science- and Risk-Based Approach to Implementation

This Overview Guide is the first in a series of ISPE PQLI Good Practice Guides (GPGs) that will describe enhanced, quality by design approaches to product realization. The Guide addresses product and process development, transfer to, and establishment of, commercial manufacture using science- and risk-based approaches. It uses ICH guidelines Q8 (R2), Pharmaceutical Development, Q9, Quality Risk Management, and Q10, Pharmaceutical Quality System as a basis, together with other relevant ICH guidelines.

Purchase online at www.ISPE.org/publications.

Connecting a World of
Pharmaceutical Knowledge



Pfizer Manufacturing Deutschland GmbH

Engineering a Long Term Sustainability Program

Introduction

According to the judging panel, **Pfizer Manufacturing Deutschland GmbH's Strategic Plant Restructuring and Energy Master Plan (SPRING and E-MAP)** project, winner of the **2011 Facility of the Year Award for Sustainability**, encompassed the engineering of a long-term sustainability program that is unparalleled in pharmaceutical manufacturing.

Located in Freiburg, Germany, the project consisted of five major projects and a series of 200 minor projects that collectively enable the facility to operate with 91% renewable energy sources, reduce its production costs by 15%, and realize a 30% energy savings.

Commitment to the Environment

The Pfizer Freiburg site, located in Germany's Black Forest region, is Pfizer's largest European facility. The plant is one of Germany's most modern production and packaging facilities for tablets and capsules. More than 230 million packs of drugs leave the Freiburg plant each year and 1,000 employees develop and produce pharmaceuticals for treating pain, cardiovascular diseases, and epilepsy.

Pfizer's environmental management credo is taken seriously at this facility. The Site Leadership Team considers the increase of automation and reduction of energy consumption and carbon footprint as an important strategic part of the facility's long-term vision.

Cost was also a major driver for Pfizer Freiburg's interest in energy efficiency. It was the increasing cost focus of the pharmaceutical industry resulting from the global economic

Pfizer Manufacturing Deutschland GmbH

Category Winner – Sustainability

Project: Strategic Plant Restructuring and Energy Master Plan (SPRING and EMAP)

Location: Freiburg, Germany

Project Mission: Look for innovative ways where GMP improvements and savings can be made to the benefit of the corporate bottom line, our colleagues, and the planet. Working together for a healthier world.

Size: 173,837 sq. ft. (16,150 sq. m.)

Total Project Cost: \$42,300,000

Duration of Construction: 40 months



Main entrance.

downturn that brought renewed interest in Pfizer Freiburg to the questions of energy efficiency.

Project Overview

A key task for Pfizer Freiburg is to identify projects that make sense from both a Green-energy and CO₂ reduction perspective. This effort resulted in the Strategic Plant Restructuring and Energy Master Plan (SPRING and E-MAP) project.

SPRING and E-MAP is a plan to optimize the manufacturing and packaging operations on site which contains five major projects and more than 200 smaller projects all aimed to implement cost- and energy-efficient technologies. Freiburg implemented the following main technologies:

- geothermal heating and cooling of office buildings



Energy tubes area in geothermal field.

Continued on page 28.

WORKING TO FILL LIVES WITH MORE YEARS AND YEARS WITH MORE LIFE.

As one of the most diversified companies in health care, Pfizer is committed to improving health and well-being at every stage of life.

Today's Pfizer is a leader in human and animal health, primary and specialty care, biologics and pharmaceuticals, with a robust portfolio of vaccines, nutritionals and consumer products.



Most importantly, we're bringing together the world's best scientific minds to take on the world's most feared diseases, with a renewed focus on areas that represent significant unmet health needs, such as Alzheimer's, diabetes, inflammation and immunology, cancer and pain.

By working together, we can change the lives of more people in more powerful and effective ways than ever before. Learn about how we're doing things differently at pfizer.com



Copyright © 2011 Pfizer Inc. All rights reserved. Wyeth is now part of Pfizer. The merger of local Wyeth and Pfizer entities may be pending in various jurisdictions and integration is subject to completion of various local legal and regulatory obligations, including works council and/or union consultations.

WORKING TOGETHER FOR A HEALTHIER WORLD.

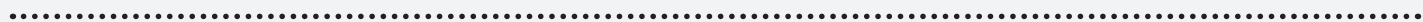



Solar panels produced green electricity.

- biomass steam for pharmaceutical manufacturing and packaging
- biomass absorption cooling for pharmaceutical manufacturing and packaging
- adiabatic cooling for laboratories and high efficiency manufacturing areas
- photovoltaic for electricity generation

Two hundred smaller projects, related especially to the implementation of employees' continuous improvement proposals include:

- electric car for the internal transports
- reduced air changes in laboratories and manufacturing area

- stand by operations in various areas
- reuse of waste water from purified water system

SPRING and E-MAP stands on three pillars: using renewables, increasing energy efficiency, and saving energy.

Renewables

Two key components of the renewables pillar are geothermal energy and changing to biomass as fuel in the heating system.

Geothermal Energy

The first major project undertaken was the installation of the geothermal heating and cooling system for the laboratory and office building. Geothermal energy was chosen because it is one of the most profitable "renewable" energy sources. Due to increasing energy prices, investments in geothermal systems pay off more quickly and it is always available regardless of the season.

A prerequisite for the use of geothermal energy and systems for heating and cooling a building is a building concept that limits the heating and cooling capacity to a minimum. This requires good heat insulation of outside walls, minimal air exchange, and outside sun protection in the summer to minimize heat absorption, thus reducing the necessary cooling capacity. Otherwise, the required heating and cooling capacity would be so high that it could only be achieved with conventional heating and cooling systems.

The system used for geothermal heating and cooling of the office building consists of a borehole heat exchanger field and a compact power station which feeds the heating and cooling

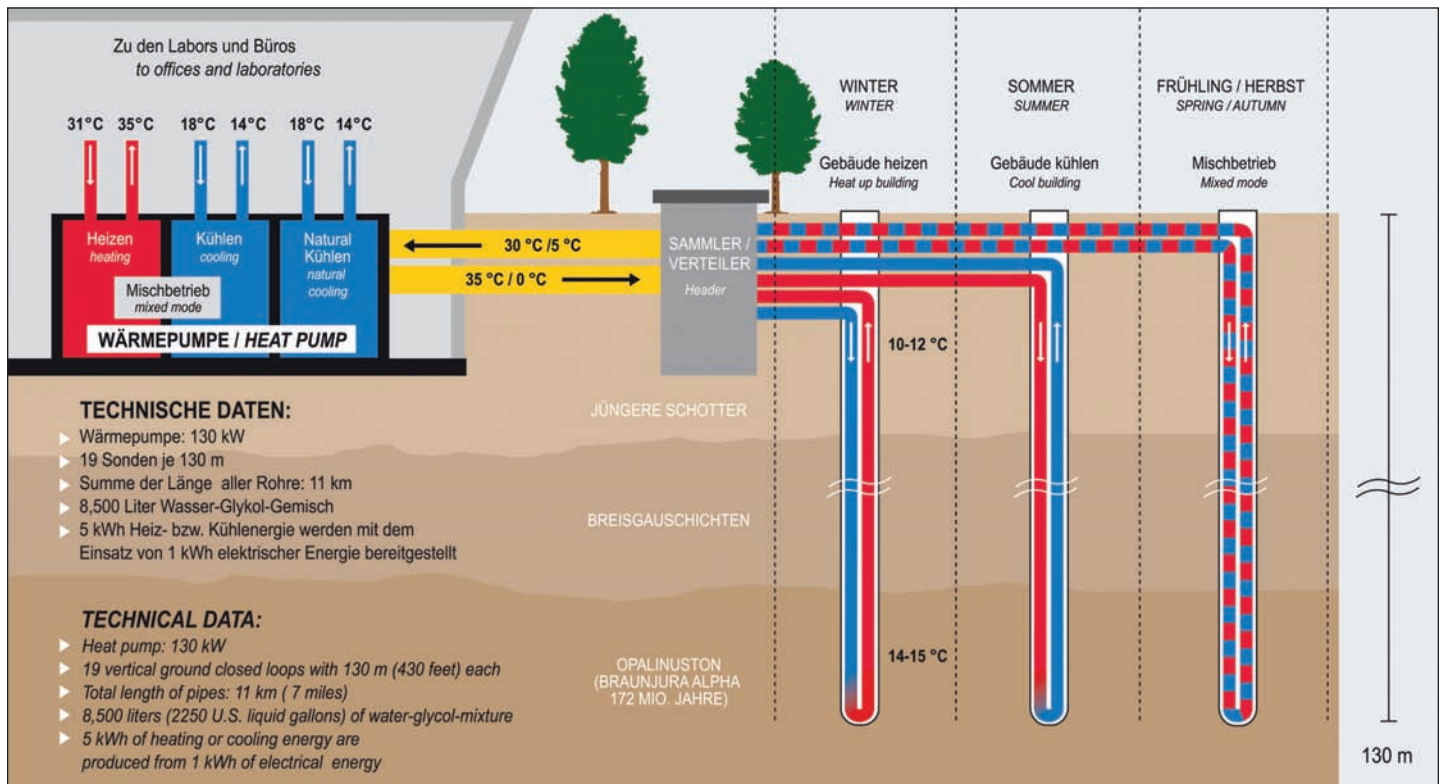

Cross section of the borehole heat exchanger field.

energy to the building services equipment. At the heart of the system is a heat pump with a nominal heat output of 130 kilowatts with an electrical output of 30 kilowatts. R407C is used as a cooling agent.

The borehole heat exchanger field consists of 19 exchangers, two collector and distributor shafts, and the piping to and from the building. Total length of the heat exchangers is 2.47 km, thus total length of the installed heat exchanger tubes is 9.9 km. The boreholes have a diameter of 15.2 cm. If the building requires heating and cooling at the same time, the system will check if there is a net heating requirement or a heat surplus in the building. Depending on the energy balance, the borehole heat exchanger field is either used as a heat source or a heat sink.

This geothermal system reduced the carbon footprint of the facility annual by 750 tons, which equals the emissions of a small city.

Wood Pellet Boiler System

A new wood pellet boiler system was installed, replacing two of four boiler systems. Touted as the Europe's largest pellet boiler, the new system generates heat and process steam almost entirely with wood pellets with a steam output of 5.5 tons per hour.

The pellets are produced from dried, untreated residue wood (sawdust, shavings, residue wood from the forest). They are compressed under high pressure without adding chemical



Wood pellet steam boiler.

binding agents and have a heat value that corresponds to the energy content of half a liter of heating oil per kilogram.

Pellets are environmentally friendly, since unlike fossil fuels, they are CO₂ neutral; during combustion, the energy sources only release the same quantity of carbon dioxide that the tree has absorbed while growing. The combustion of pellets releases less sulfur dioxide than conventional wood combustion. Since this gas contributes to the formation of acid rain, the conversion to pellets as a fuel also helps protect local forests.

Why Our Project Should Win

The following is an excerpt from Pfizer Manufacturing Deutschland GmbH's submission, stating in their own words, the top reasons why their project should win the 2011 Facility of the Year Award:

- The vision driven long-term strategy of transforming Pfizer Freiburg into a green facility led to a beacon sustainability concept. Pfizer Freiburg realized a powerful multi-pronged approach. The measures not only include spectacular individual measures, but they also secure the site's impressive high energy standard and considerably reduce its environmental impact at the same time.
- Converting a classical production site to the use of renewable energy sources at an industrial scale is unique. Pfizer Freiburg is the largest packaging site in the Pfizer network. The entire site made a far-reaching change to renewables: 91% of the required primary energy is generated using renewable energy sources. EU provisions for 2020 are thus already today far exceeded. The findings on the payback cycles (three years only) and cost-effectiveness (30% energy cost reduction) in industrial applications are groundbreaking for the entire pharmaceutical field.
- Outstanding reduction of greenhouse gas emissions: Pfizer slashed carbon dioxide gas emissions by 80% by employing Six Sigma and lean methods. The savings totaled 7,000 tons, which equal the emissions of a small city. The company exceeded EU provisions targeted for 2020 and can be considered to be very well prepared for the future challenges in the field of energy self-sufficiency and energy supply security. In 2011, Freiburg could reduce the overall CO₂ emissions below 650 tons CO₂ (in 2005, it was 13,500 tons CO₂).
- Pfizer Freiburg's SPRING and E-MAP revealed the enormous potential the move to renewable and energy efficiency contained for the pharmaceutical industry. Increasing cost pressure has been answered with product cost-savings of 15% by combining the economic advantages with environmental benefits. Additionally, we promote all the green achievements proactively as a "lighthouse as guide to a healthier world" to increase the acceptance within Pfizer and the industry.
- The pioneering spirit of the employees considerably drives the company's power. Pfizer employees create a more desirable workplace and Pfizer becomes the best place to work. The participative approach of SPRING and E-MAP which was core to the plan increased employees motivation in facility engineering management regarding environmental issues and raised the company's credibility in dealing with local authorities and external stakeholders.

Concludes on page 30.

Notes from the Judging Panel – What Impressed Them

- Overall it was an excellent project.
- The project exemplifies what Sustainability is all about. The implementation of the SPRING and E-MAP to optimize operations generated impressive results for this pharmaceutical manufacturing plant.
- The innovative and forward thinking plan consisting of five major projects and a series of 200 minor projects collectively enabled the facility to operate with 91% renewable energy sources. Additionally, there was an energy savings of 30%.
- Most impressive to the judges was how Freiburg engineered a long term sustainability program that is unparalleled in pharmaceutical manufacturing.

Award Category – Sustainability

Winners in this category exemplify the application of novel approaches, tools, and techniques intended to improve effective use of energy, minimize waste, reduce carbon footprint, incorporate green manufacturing techniques, reduce environmental impact, and result in more efficient processing, utilities support, and business advantage.

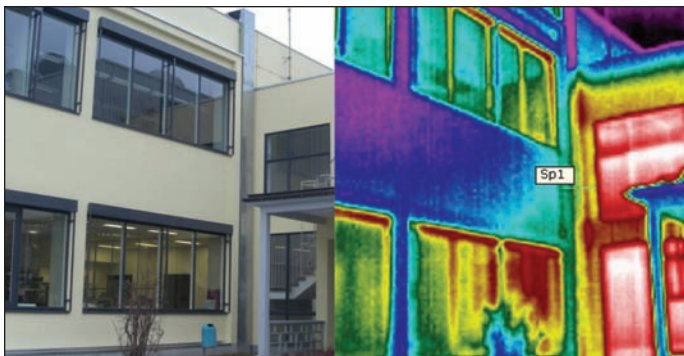

Thermo graphic inspection shows heat loss.

While crude oil and natural gas are becoming scarcer and more expensive, the production of pellets is increasing steadily. Wood is available locally. According to Pfizer, in times of global crises and long transportation distances, local fuels are a stabilizing element. Due to sustainable, natural forest management, wood as a fuel will continue to be available in the long term.

According to Pfizer, the new biomass fuel system saves the environment 5,500 tons of carbon dioxide annually as well as six-figure heating costs for the company and in the future, will provide around 85% of the heat and steam required at Freiburg.

Key Project Participants

Designer/Architect: Architekturbüro Frey (Bingen am Rhein, Germany)
Main/General Contractor: Siemens Axiva (Frankfurt am Main, Germany)
Innovation Support: The Freiburg team is collaborating with The University of Freiburg and Offenburg PMD Germany and ZEE-REM (Green Universities of the City of Freiburg in a collaboration of other universities under the umbrella of the ZEE Centre for Renewable Energy) <http://www.studium.uni-freiburg.de/>.

Efficiency

Many achievements were accomplished by fine tuning detailed tasks, together having an enormous effect on the site's energy balance. Technicians optimized the many ways building management systems were controlled. A broad range of projects were initiated, including: reducing the number of circuits using frequency converters in the neutralization process or in the generation of compressed air; increasing the service life of drives and reducing energy consumption; cooling laboratories and office buildings with evaporating water (adiabatic cooling) as an alternative to using compressors which require a great deal of energy; and employing heating and cooling ceilings, which use less energy than conventional radiators.

Saving Energy

Pfizer Freiburg improved the insulation of outer walls, invested in high thermal insulated windows, and reduced the cooling energy requirements in the summer by using an automatic sun shading system. An intelligent lighting system ensures that energy is only used where it is actually needed. The air exchange rate of the ventilation system is easily adjusted to the actual requirements in different GMP rooms at the touch of a button.

Conclusion

SPRING and E-MAP's energy framework is filled with numerous, carefully targeted individual measures to increase energy efficiency or save energy. The end result is not a fixed point, rather a manufacturing plant that can be just as dynamically adjusted to changes as the company itself. Pfizer's ambitious goal is to be open-minded toward the future and to prepare future developments today. The investments made in environmental and climate protection are paying off. The facility is operating with 91% renewable energy sources, reduced its production costs by 15%, and realized a 30% energy savings. 🌱

ISPE would like to thank the following companies for their generous advertising support which made this Supplement possible.

Advertiser's Index

CRB ENGINEERS AND BUILDERS	43
EMERSON PROCESS MANAGEMENT.....	48
FLUOR ENTERPRISES INC	7
FRISTAM PUMPS USA.....	5
GRONINGER USA LLC	39
IPS	15
M + W PROCESS INDUSTRIES GMBH	21
PALL LIFE SCIENCES	9
PFIZER CENTRESOURCE	33
PFIZER MANUFACTURING DEUTSCHLAND GMBH	27
PM GROUP.....	2
PROSCON LTD.	37
REES SCIENTIFIC	41
SKANSKA USA BUILDING INC.....	19
TECHNISERV	13



www.facilityoftheyear.org

The Facility of the Year Award is sponsored by:



Connecting a World of
Pharmaceutical Knowledge

INNOVATION + INTELLIGENCE + PASSION
INTERPHEX 2011™

**Pharmaceutical
Processing**

FACILITY OF THE YEAR SUPPLEMENT STAFF

Publications

Editor and Director of Publications

Gloria N. Hall

Publications Manager

Lynda D. Goldbach

Technical Writer

Rochelle Runas

Publications Coordinator

Angie Brumley

Sales

Director of International Sales

John Phillips

North American Sales Associate

Daniel Murphy

Sales Support Coordinator

Juan Garcia

"Acting" European Sales Manager

Michel Marques

Business Initiatives

Director of Business Initiatives

Scott Ludlum

Business Initiatives Coordinator

Cicelle Domingo

Pfizer Health AB

An Operation of Great Ingenuity

Introduction

Pfizer Health AB's Bio 7 Manufacturing Facility, a new microbial drug substance production facility at Pfizer's production site in Strängnäs, Sweden, was designed and constructed primarily to manufacture two legacy Pfizer products that have opposite effects on the human physiology, yet are similar molecules. Pfizer scientists explored this similarity to develop an innovative manufacturing process with virtually identical unit operations that could be utilized for both products.

Project Pegasus – Bio 7 Manufacturing Facility was named winner of the **2011 Facility of the Year Award for Operational Excellence** for Pfizer's ability to bring a new facility online with added capacity without additional headcount or extended shift patterns. This was achieved by incorporating a high degree of flexibility into the facility design and developing and implementing key design and process enhancements.

Project Drivers

Genotropin®, which has been on the market for 24 years, is a recombinant Human Growth Hormone (rHGH) used for the treatment of growth hormone deficiency. Somavert®, which has been on the market for 13 years, is a growth hormone antagonist used for the treatment of acromegaly (over-production of growth hormone). Genotropin was and still is partly manufactured in an existing facility at the Strängnäs site, while Somavert DS was sourced from a contract manufacturer.

The drivers for constructing a new facility were several fold, including bringing Somavert manufacture in house, thus



Exterior view.

reducing the cost of goods; introducing improved processes designed to increase yield; eliminating capacity constraints in the existing facility; eliminating animal derived products; and reducing cycle time. Other fundamental criteria were the need to maintain existing head count and limit the operations schedule to a two shift pattern with no night shift.

Project Overview

Bio 7 is a two story facility with interstitial space between floors. Total floor space is 54,465 sq. ft. (5,060 sq. m.). An additional 5,380 sq. ft. (500 sq. m.) in an existing building was retrofitted to facilitate installation of a buffer and media preparation facility including filtration room. The Strängnäs site was chosen for this new facility due to the manufacturing know how on site, presence of existing utilities with sufficient capacity to simultaneously serve the existing and new facility, and available space for the new facility plus any future expansion.

Pfizer Health AB

Category Winner – Operational Excellence

Project: Pegasus – Bio 7 Manufacturing Facility

Location: Strängnäs, Sweden

Project Mission: Establish a strategic facility of technical and quality excellence for Genotropin and Somavert drug substance and future microbial cell products; realize cost benefits from more efficient processes and in-house manufacturing of Somavert; change to animal free media for supply assurance; assure long term capacity for both products

Size: 54,465 sq. ft. (5,060 sq. m.)

Total Project Cost: \$188,700,000

Duration of Construction: 25 months



Bio 7 under construction.

Continued on page 34.

Our Award-Winning Expertise ...to Benefit *Your* Microbial Products

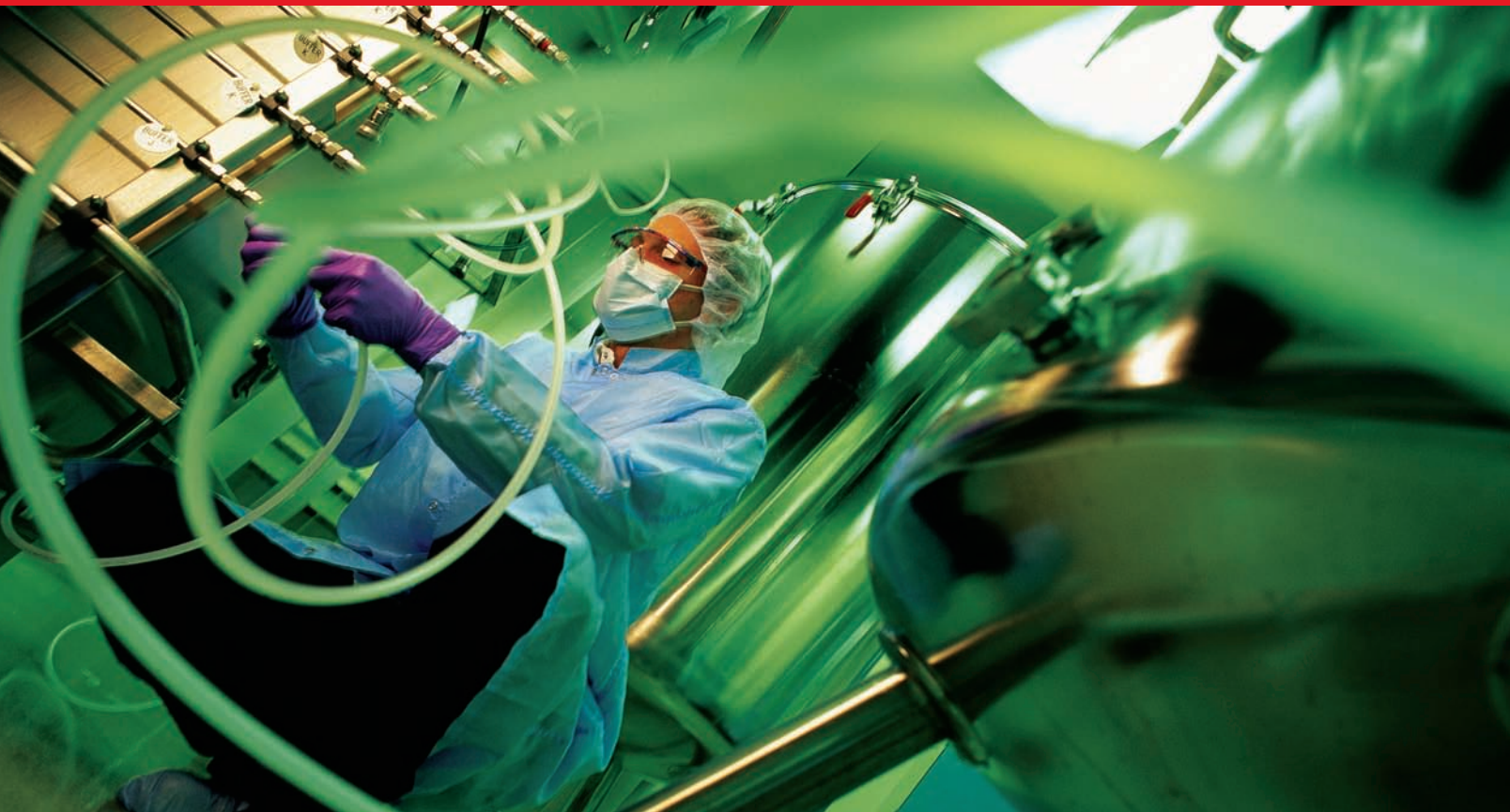

Operational Excellence in Microbial Manufacturing

Pfizer CentreSource delivers innovative, high quality services that leverage Pfizer's award-winning leadership in biologics development and manufacturing across microbial platforms. And with Pfizer's advanced facilities, regulatory track record, and highly experienced bio-therapeutics professionals, we can apply Operational Excellence to manufacturing therapeutic proteins in a way that benefits your product, and your bottom line.

Among the capabilities available to Pfizer CentreSource customers are:

- Industry-leading protein expression technologies
- Expertise in biological product characterization
- Clinical-scientific and regulatory development know-how
- Biologics manufacturing and supply chain experience
- Extensive drug product and cold chain operations

The Americas: +1.269.833.5844
Europe/Middle East/Africa: +32.2.714.6502
Asia Pacific: +65.6419.0248
centresource.info@pfizer.com
www.pfizercentresource.com



Pfizer's Project Pegasus - Bio 7 Manufacturing Facility in Strängnäs, Sweden, is a 2011 Facility of the Year Award (FOYA) winner for Operational Excellence.

PfizerCentreSource

Partnering with our customers for a Healthier World™



The facility design was based on closed processing utilizing stainless steel equipment which minimized cleanroom requirements. The facility contains two independent fermenter trains, each configured with a 300 L seed fermenter, 3,000 L main fermenter and two support vessels. This is followed by one process equipment train from harvest and product recovery, downstream purification, to formulation and bulk filling. The facility is highly automated utilizing a control system and a limited number of packages utilizing PLCs, e.g., autoclaves, washers, centrifuge, etc.

Streamlining for Efficiency

While Genotropin and Somavert have opposite effects on the human physiology, they are similar molecules. Pfizer development scientists exploited this similarity to develop an innovative manufacturing process with virtually identical unit operations that could be utilized for both products. The old manufacturing process for these two products are completely different; therefore, the creation of a common manufacturing platform was of enormous benefit to Pfizer in terms of reducing capital investment required for the facility and enhancing operational excellence. In addition to creating a common manufacturing



Fermenter super skid – assembled at vendor workshop prior to FAT.

platform, the batch yields have increased significantly.

Minimizing manual interactions in the process was a key feature of the design intent to allow the control system to run seamlessly from one process step to another. This intent

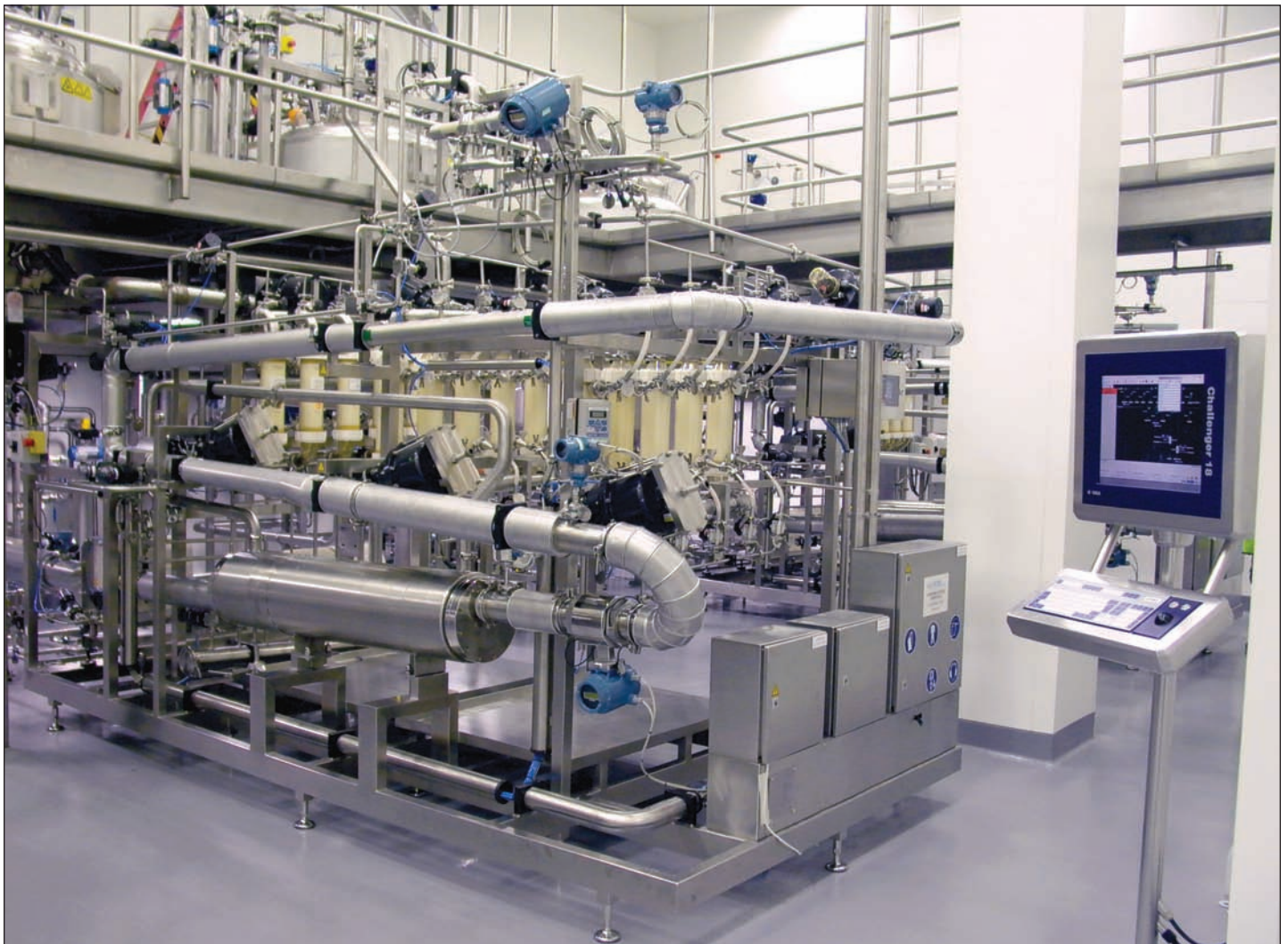

Harvest area – microfiltration skid (cell removal unit operation).

is reflected in several features of the design, including use of automated valves instead of transfer panels, very few inline filters, TFF skids with automated integrity testing capability, and vessel vent filter configuration.

Another key feature of the facility is the control system recipes, which when activated, run through the entire process

from buffer preparation to CIP post bulk filling.

Minimizing equipment cleaning times was identified very early in the project as a critical goal to ensure maximum facility efficiency. The elimination of SIP functionality in the downstream processing area was another key decision in the drive to achieving a highly efficient facility.

Why Our Project Should Win

The following is an excerpt from Pfizer Health AB's submission, stating in their own words, the top reasons why their project should win the 2011 Facility of the Year Award:

Operational Excellence

- Pfizer has realized a facility which is extremely efficient and truly fit for purpose. In the current environment where cost is of the utmost importance, the Pfizer Strängnäs Bio 7 Facility is an example of how to create efficiency and significantly reduce cost of goods without incurring excessive capital investment cost.
- The goal of Project Pegasus was not just to deliver a functional facility, but also a facility which would operate in a lean fashion without requiring an extended shift pattern or additional head count.
- Excellent efficiency creates additional capacity in the facility which, when taken up with new products, reduces capital depreciation effect on cost of goods. While the original requirement was to allow for processing of two batches per week, the facility can process an estimated 3.5 batches per week and this can be further increased with minor optimizations.

Project Execution

- The early creation of a highly competent and experienced Pfizer team, which was in place for the duration of the project, greatly assisted the goal of meeting budget and schedule while delivering a facility which is fit for purpose, efficient, and ergonomic. The wealth of experience and operational know-how in the Pfizer team provided enormous added value to the facility design and reduced overall project risk. Completing the C&Q execution within six months was a major achievement for Pfizer and was due in no small part to the expert knowledge provided by the Pfizer team during the design phase.
- Despite the very complex nature of many aspects of the manufacturing process, the commissioning effort was completed ahead of schedule and the facility is now operating in a very robust manner. There has only been one instance of microbial contamination for a total of 32 batches completed in the facility, which is excellent for a start-up of this size.
- An exceptional value engineering exercise was undertaken, which not only significantly reduced capital investment cost, but also contributed to facility efficiency by optimiz-

ing overall facility ergonomics and reducing maintenance requirements.

User Friendly – Ergonomic

- While delivering a functional facility within budget and on schedule is the standard measure of a project's success or failure, the Pegasus management team gave equal weight to facility operability. From an operations perspective, the new Bio 7 facility is extremely user friendly and ergonomically smart. This is based on feedback from operators and maintenance personnel, many of whom have worked in several different facilities. This is a vindication of the continuous involvement of Pfizer mechanical, process, operations, E&I and EHS personnel in the 3D model review of the facility.
- This also contributes to the efficiency of a facility as it allows for faster turn-around and maintenance of equipment.

Innovation and Flexibility

- Creating a cost effective facility of exceptional efficiency required the application of innovative design and processing techniques in several areas of the manufacturing process. The successful use of in-line dilution in combination with gradient generation on chromatography unit operations is one example. Concurrently running multiple unit operations in the harvest area is an example of utilizing innovative processing techniques to reduce processing time and save on capital investment. Reconfiguring the primary WFI loop to a self contained recirculation loop also displayed innovative thinking to resolve a challenging problem.
- While the Bio 7 Facility makes limited use of disposable technology, the equipment configuration allows the manufacturing platform to be easily configured for new microbial based fermentation products.

Reduction in Cost of Goods

- The significantly higher fermentation titers, higher step yields, reduced number of unit operations, and introduction of "batch oneness" has significantly reduced batch release time and overall cost of goods. While the previous Genotropin process required a total of 18 batches to create one final batch, the new process takes a single batch from fermentation to bulk fill. This greatly reduces batch release time and simplifies investigations as traceability is straightforward.

Concludes on page 36.

Notes from the Judging Panel – What Impressed Them

- *Nice job of optimizing existing processes, good risk management, and a good job on allowing for reuse of buffer filters*
- *Due to incorporating a high degree of flexibility into the facility design process, Project Pegasus was able to bring a new facility online with added capacity without the addition of any headcount or extended shift patterns.*
- *The project team did a good job of minimizing manual interactions in the process, enabling seamless movement through process steps.*
- *Key design elements, including the minimization of equipment cleaning time and elimination of SIP in downstream processing enhanced efficiency.*
- *As a result of the focus by the Pfizer team on Operational Excellence, the facility has an estimated capacity of 3.5 batches per week as opposed to the original target of two.*

Award Category – Operational Excellence

Winners in this category exemplify the application of modern management techniques aimed to improve operating efficiencies, promote excellent quality, consistency, and yield competitive cost of goods from existing and new facilities, processes, and manufacturing operations.

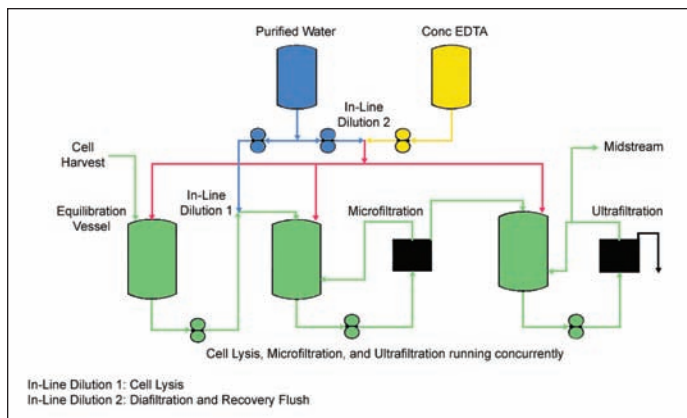

Integrated harvest unit operations.

Process enhancements such as membrane flushes, integrated harvest operations, multi batch buffers, and positioning of liquid filter housings are additional examples of the team's focus on operational excellence.

While the new manufacturing processes were well developed, there were a number of unknowns and additional optimization which the development group worked on during the facility design. A Pfizer team of experienced process engineers with extensive hands-on commissioning, process optimization, and debottlenecking experience were key to realizing an efficient facility.

Key Project Participants

Designer/Architect: Jacobs UK Ltd. (London, UK)/Sweco (Stockholm, Sweden)

Construction Manager: Pfizer

Main/General Contractor: Skanska (Solna, Sweden) *(See ad on page 19)*

Conclusion

Project Pegasus was able to bring online the Bio 7 Manufacturing facility with added capacity without the addition of any headcount or extended shift patterns. This was achieved by incorporating a high degree of flexibility into the facility design. The project team also had to minimize manual interactions in the process, enabling seamless movement through process steps. Control system recipes were developed that run from the buffer preparation through CIP. Minimizing equipment cleaning time and elimination of SIP in downstream processing were also key design elements that enhanced the efficiency of this biotech operation. Process enhancements demonstrated the team's focus on operational excellence. Targeted output of the facility was two batches per week, but as a result of the team's focus on operational excellence, the facility has the capacity for up to 3.5 batches per week. 🏆



Downstream processing area – chromatography skid and column.



Rockwell Automation would like to congratulate Pfizer Health AB on winning the FOYA category in Operational Excellence for the Pegasus Project in Stragnas, Sweden.

LISTEN. The Rockwell Automation EMEA Life Sciences team are delighted to have
THINK. been involved in delivering a component of a successful FOYA category
SOLVE. winner for a third consecutive year. If you require an Automation/MES/
Process Technology partner or are looking for further information on how we could assist
you in delivering an award winning facility please visit our website:

www.rockwellautomation.com/industries/lifesciences



F. Hoffmann – La Roche Ltd

Innovative Process Ensures Innovative Drug Delivery to Patients

Introduction

The Roche Global Engineering Department received its instructions from the Roche Board: design and construct a facility capable of producing a device with completely new technology in a small space and extremely aggressive time frame.

The device, called MyDose, is a single-use infusion device which is a new platform for automatic drug delivery of high volume drugs to patients. The device consists of 83 individual components and requires 40 production steps to manufacture.

Thirteen months later, the first MyDose devices were produced in the **MyDose Clinical Supply** facility in Kaiseraugst, Switzerland. Deemed by the judging panel as a project that demonstrated excellent innovation in the industry, the facility is the winner of the **2011 Facility of the Year Award for Process Innovation**.

To meet this project's unique requirements, Roche employed a combination of existing, proven technology and specific customizations. In some cases, entirely new applications served as a basis for the manufacturing process layout. Assembly and welding of the fluid path components of the MyDose device is the most complex step and required the installation of a laser welding process in a cleanroom environment. The process design and development were critical success factors of Roche's new delivery platform.

The MyDose Device

MyDose is the trade name for a single use infusion device that enables the subcutaneous administration of large quantities (up to 15 ml) of liquid medicine. The medicine is a new formula-



Exterior view of facility.

tion of drugs which allows various monoclonal antibodies to be delivered. MyDose's main functional component is a Vartridge (hybrid between a vial and a cartridge), housed in the fluid path container and set in motion by a motorized drive.

Vials and cartridges are glass containers for drugs with a closure. The vial is similar to a bottle with a bottom. The cartridge is a slim glass tube (diameter between 6 to 9 mm) equipped with a piston to close the container at the bottom. The patented Vartridge is a hybrid between both. The design of the piston is unique as well. The conic form of the piston ensures that the Vartridge will be completely emptied when the piston is pressed down.

Administration of the MyDose Device is simple. The patient puts the device on the stomach. An adhesive patch attached to

F. Hoffmann – La Roche Ltd

Category Winner – Process Innovation

Project: MyDose Clinical Supply facility

Location: Kaiseraugst, Switzerland

Project Mission: A new production facility with state of the art process modules tailored specifically to the production of innovative MyDose device.

Size: 3,444 sq. ft. (320 sq. m.)

Total Project Cost: \$11,891,102

Duration of Construction: 7 months

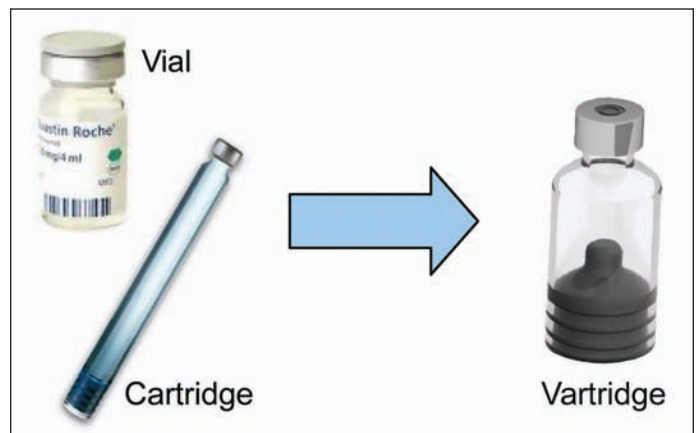

The Vartridge is a hybrid between a vial and a cartridge.

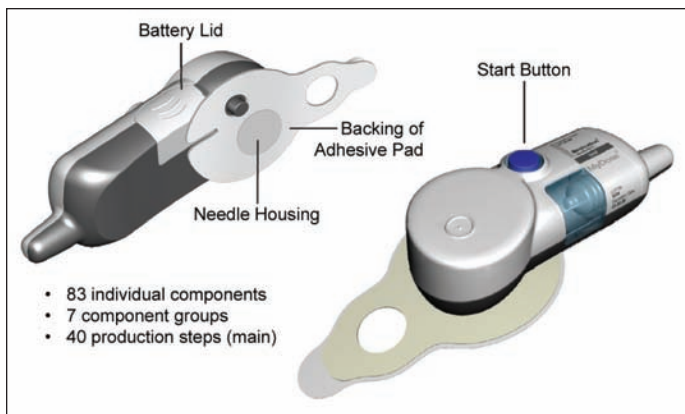

MyDose device.

the device keeps the device in place. The mechanism is activated by pressing the start button. A sterile needle penetrates the abdominal wall. The battery driven motor depresses the piston down. The drug is injected subcutaneously.

The MyDose Facility

The MyDose Clinical Supply facility is situated at Roche's Kaiseraugst site, which has become a thriving center for galenical manufacturing and hosts the largest and most up to date packaging and logistics facilities for Roche. The Kaiseraugst

facility supplies 120 million packages of medicine each year to 130 countries.

The device components and medicine are sourced globally, containing drug substance requiring application volumes from 3 to 15 ml, with pre-assembly of components (base, cover, fluid path) in Ireland; API production in Penzberg, Germany; plastic component manufacture in Asia; and compounding in Basel, Switzerland.

Sterile filling, welding, final assembly, and packaging take place at the MyDose Clinical Supply facility on the Kaiseraugst site in Building 231. The new production area was installed in existing space on the second floor. It encompassed 3,444 sq. ft. (320 sq. m.) separated into five cleanroom classes. Zone Grad G (controlled, not classified) accommodates the technical area providing the infrastructure for the production. All production rooms follow cGMP zone classification standards.

Process Overview

The production process for the MyDose device is unique as no other product in galenical manufacturing demands so many state of the art (off the shelf) production steps. The challenges associated with developing and designing the device were vastly outweighed by the challenges of producing the correct, optimized manufacturing process layout in a relatively small existing space and under enormous time pressure.

Due to time pressures, existing technology was adopted as

Continued on page 40.

Specialist in filling and packaging machines



The power of precision

Production Lines for Vials, Syringes and Cartridges

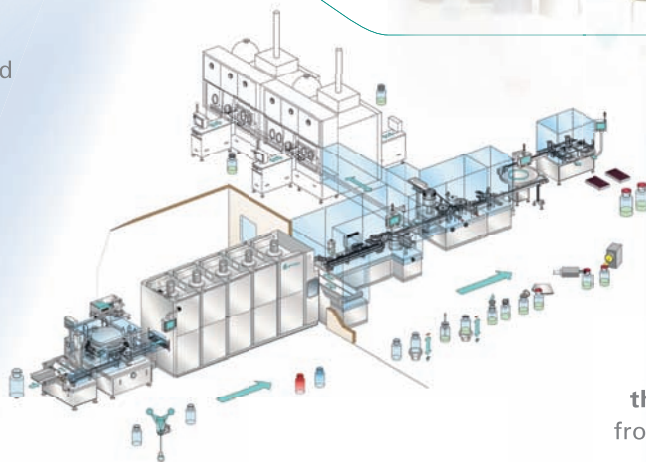

the power of efficiency – from design to production

@ www.groningerusa.com



Interphex 2011 in New York, March 29-31, booth 3671

South Pack 2011 in Tampa (FL), March 16-17, booth 1607

Interpack 2011 in Duesseldorf/Germany, May 12-18, booth A23-B24

HBA 2011 in New York (NY), June 28-30, booth 975

groninger USA L.L.C. · 2520 Whitehall Park Drive · Suite · 800Charlotte · NC 28273 · USA · phone: +1(704)295-9000e-mail: info@groningerusa.com



Vartridge filling and closing unit.

the basis for the manufacturing process layout. Where necessary, the proven technology was supplemented by either specific customization or entirely new applications, specifically:

- Multiple production steps resulted in extreme space restrictions and additional equipment to be qualified and validated.
- New liquid Vartridge required the modification of standard machines for production steps such as washing, siliconization, and filling.
- Strict temperature control was required during the whole production process as the innovative enzyme is extremely sensitive to temperature changes.
- The zoning concepts were extremely strict. The product requires Zone Grade C (ISO 8) with Grade A (ISO 5) air supply for the filled Vartridge from inspection until welding process.
- The unique integration of a laser welding process under cleanroom conditions [Zone Grade C (ISO 8) with Grade A (ISO 5) air supply] produced a bottleneck in production, which had to be designed out of this process.
- Production of the device involves many more steps and components than a normal auto injector device. This in turn

Why Our Project Should Win

The following is an excerpt from Roche's submission, stating in their own words, the top reasons why their project should win the 2011 Facility of the Year Award:

A major advance in ensuring supply of an innovative oncology drug to patients

- This allows substances usually administered intravenously to be given via subcutaneous injection. The LifeCycle Leader for this product confirms the benefits for the patient: "The subcutaneous formulation and the associated new administration device will greatly simplify patients' lives. There is also hope that patients will experience fewer infusion reactions through slower absorption after subcutaneous administration."

Exemplary project management and leadership, excellence in project procurement, expediting, and quality control

- Project execution within 13 months from kick-off
- Empowering and integrating the whole project team of service providers, suppliers, trade contractors, designers, engineers, and Roche
- Great team spirit and participation and with an outstanding focus on the key project goals
- Outstanding performance in product and process innovation
- Implementation of innovative design and execution strategies with high degree of flexibility and adaptability during all project phases

Milestone in Product Innovation with regard to the concept, materialization of functional requirements, and integration with technological advances

- The creation of a new platform for "automatic" drug-delivery of high volume drugs to patients was only

possible after the project team integrated several major technological advances.

- New enzyme which allows substances usually administered intravenously to be given via subcutaneous injection. When administered subcutaneously, technology temporarily opens a small cavity in the tissue, which allows painless injection.
- A hybrid vial/cartridge which would provide the necessary volume on the one hand and ability to inject on the other, named "Vartridge."

Excellence in Process Innovation and integration of several state of the art technologies

- Introducing laser welding process under cleanroom conditions (ISO 5)
- Temperature limits and restrictions of cooling free time due to the nature of the innovative enzyme which requires rigorous controlled process operation time with optimized material flows and limited idle time
- Embedding and integrating welding as a complex process in a conventional process of filling and finishing sterile drugs
- Filling and closing of a high volume (5 ml, 10 ml, 15 ml) vial/cartridge hybrid called "Vartridge"

Value Stream Map and a unique approach to derive facility and business benefit

- Utilization of production planning tools enabled to identify bottleneck areas.
- Material flow was analyzed in-depth and helped establish the most efficient arrangement of material, equipment, and human resources to streamline the production process.
- Pallet storage space was evaluated and incorporated into the layout.

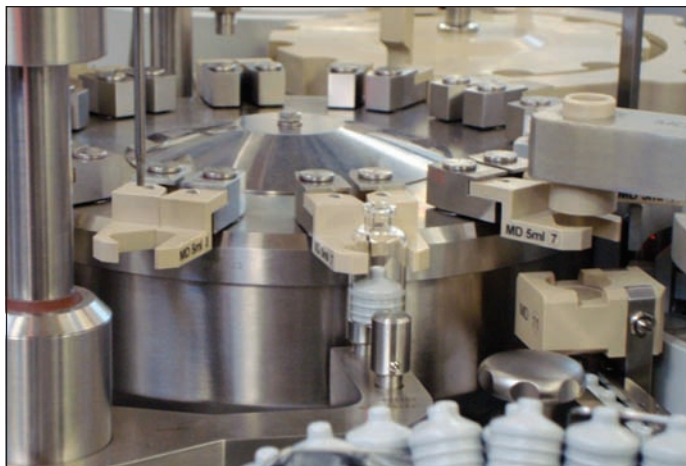

Vartridge with piston in filling machine.

produces more interaction between incoming goods and Work in Progress goods as well as the problem of storing the necessary inventory in an already confined facility space.

The value-adding steps in the production of the MyDose Device can be grouped into the following four major segments:

1. Vartridges delivered to the production line in trays followed by careful washing, silinconizing, depyrogenization, sterile filling, and closing of the Vartridge to provide for the core characteristic of the product



Part of the assembling and welding process.

2. Manual quality inspection
3. Assembly and welding of the fluid path components (Vartridge, cartridge holder, and transfer unit) to produce the finished fluid path
4. Further assembly including base plat, housing, fluid path, and plaster before country specific labeling and packaging

Step three was the most complex. The biggest challenge was to install the assembling and welding process under cleanroom con-

Concludes on page 42.

AUTOMATED TEMPERATURE MONITORING COMPLIANCE THROUGH INNOVATION

Monitoring of...

Refrigerators
Freezers
Incubators
Stability Chambers



Alarming of...

Temperature
Humidity
Differential Pressure



Thoroughly Validated Solution

Meet GxP, FDA, AAALAC, USDA, and other regulatory requirements

wireless
Rees Scientific V.2

Our next generation of wireless monitoring provides:



- *Data reliability
- *Robust security
- *Wireless flexibility



REES SCIENTIFIC
ISO 9001:2008 Company

1007 Whitehead Road Ext. Trenton, NJ 08638 Ph/800.327.3141
Fax/609.671.2751 Sales@reesscientific.com www.reesscientific.com

Notes from the Judging Panel – What Impressed Them

- Overall, the project excelled, especially in Process Innovation.
- The project demonstrates excellent innovation in the industry.
- The complex design and development components of the project were critical success factors in enabling Roche to create a new delivery platform for automatic drug delivery of high volume drugs to patients.

Award Category – Process Innovation

Winners in this category exemplify the application of novel process manufacturing techniques on existing and new facilities, including fundamental scientific processing approaches and related applied science-based solutions to existing and new challenges.



Assembling and welding machine robot.



Robot picks a filled Vartridge.

ditions [Zone Grade C (ISO 8) with Grade A (ISO 5) air supply]. After filling, closing, and inspection of each Vartridge transport is enabled by using special designed trays. The transfer unit and cartridge holder arrives sterilized in tubs. Trays and tubs are delivered manually to the assembly and welding machine.

A cleanroom validated robot picks the three components (transfer unit, filled Vartridge, and cartridge holder) one after another and assembles them. The laser welding process under controlled conditions follows to seal the transfer unit with the cartridge holder. This new component is called a fluid path. It must be air tight to guarantee sterility.

The production process underwent several major changes during the project as the design of the devices developed and the full implications of the production process were understood. For example, some of the crucial production steps, such as laser welding of fluid path components under cleanroom conditions, proved to be difficult to achieve in the time frame available.

Conclusion

The MyDose project was delivered as an ultra fast track project to meet the clinical supply milestone thus ensuring the delivery of an innovative oncology drug to patients. In order to achieve the very demanding time lines, the project team had to innovate process design and development of new machine technologies, which were the critical success factors in this project.

The Roche Global Engineering team surpassed its project goals. Handover of the facility – with complete functionality of the building, process equipment, and process automation – to the development department was accomplished within 13 months after kick-off. Performance lots had been successfully produced ahead of the original fast track schedule scenario and without any technical problems. All this was achieved as a result of the meticulous care invested in every planning and execution phase. 

Key Project Participants

Architect/Design Manager/Engineer/Construction Manager:
Roche (Basel, Switzerland)

HVAC Subcontractor: M + W Group GmbH (Stuttgart, Germany) *(See ad on page 21)*

Major Equipment Suppliers/Contractors:

- OPTIMA Packaging Group GmbH (Schwäbisch Hall, Germany)
- Insys Industriesysteme AG (Münsingen, Switzerland)



KLING STUBBINS



CONGRATULATIONS SHIRE

2011 Facility of the Year Awards Honorable Mention



CRB, KlingStubbins and Bovis Lend Lease would like to congratulate Shire for the recognition of Project Atlas as Honorable Mention in the 2011 Facility of the Year Awards program. Project Atlas' entire upstream process line utilizes single-use technology and is the first plant to use a single-use sterile train at the 2,000 liter scale, which required a number of custom modifications. Atlas also employs a number of single-use technologies in the downstream processing, such as buffer hold and centrifugal filtration. This technology along with the overall design led to a facility smaller in size with diminished utility requirements and more than a quarter fewer carbon emissions than a comparable stainless facility.

While the use of cutting-edge technology makes Atlas stand out among its stainless steel contemporaries, perhaps even more impressive was the execution of the project. Atlas utilized an integrated design and construction approach, integrated commissioning and validation, and a fully working mock-up of the Atlas facility's sterile train, dubbed Sandbox. Teamwork and agility were the defining characteristics for the Atlas team, and both were critical for delivering the project—ahead of schedule and under budget—amidst a remarkable series of challenges introduced by market forces and opportunities.

Congratulations Shire! Thanks for allowing us to be a part of your team.

Shire Human Genetic Therapies (HGT) Brave as the People they Help

Shire pursues opportunities on behalf of patients and families facing such rare conditions as Fabry disease, Hunter syndrome, Gaucher disease, hereditary antioedema, and metachromatic leukodystrophy – patients whose lives often hinge on the discovery and delivery of extraordinary medicines. Shire Human Genetic Therapies (HGT), a business unit of Shire, is dedicated to the study of rare genetic diseases, many of which are treated by the enzyme replacement therapies produced in their new facility, Building 400, in Lexington, Massachusetts, USA.

Project Atlas, Building 400, winner of the **2011 Facility of the Year Award Honorable Mention**, pushed the envelope with its extensive deployment of single use technologies at commercial scale and its implementation of fully single-use upstream process technology at 2,000 liter scale.

Project Atlas, Building 400, is the company's third cell culture facility, intended to support the manufacture of Replagal®, which helps treat Fabry disease, and VPRIV®, a medication for type 1 Gaucher disease, as well as a robust product pipeline for future programs. The building features cell culture suites, purification suites, support services, and a large administrative space.

Speed to market was the primary driver for the facility's design; Shire faced unmet demand for their present therapies. A feasibility study on the use of single-use technology versus stainless steel discovered a number of benefits in favor of disposable or single-use technology, including: 1) reduced build time/time to market, 2) decreased contamination risk, 3) reduced cost of goods, 4) increased flexibility, and 5) reduced environmental impact. Additional benefits included decreased cycling time, decreased system complexity, and increased throughput.

The study also compared a standard hypothetical stainless steel facility to a comparable single-use facility, revealing that a single-use facility would result in a:

- 34% reduction in total facility size
- 40% reduction in initial capital costs

Shire HGT

Honorable Mention

Project: Atlas, Building 400

Location: Lexington, Massachusetts, USA

Project Mission: We enable people with life altering conditions to lead better lives.

Size: 200,000 sq. ft. (18,581 sq. m.)

Total Project Cost: \$230,000,000

Duration of Construction: 24 months



Aerial view of Project Atlas with trailers.

- 10% to 20% reduction in cost of goods
- 70% to 95% reduction in water use
- 50% to 75% energy savings
- 40% to 50% shorter project schedule

Despite the benefits, the design team was concerned with proceeding with fully single-use upstream process technology. Single-use technology had yet to be proven at the 2,000 liter scale, and the fledgling single-use system industry posed some considerable supply chain uncertainties as new suppliers overcame barriers to entry and other struggled to sustain growth. However, the benefits to single-use technology were too significant to overlook, and Shire and its partners felt that as a team, they could achieve their goals by leveraging their collective expertise and that of their suppliers to develop the technology both time- and cost-effectively.

Project Atlas' entire upstream process line utilizes single-use



A full working mock-up of the sterile train located offsite.

Notes from the Judging Panel – What Impressed Them

- *Project Atlas, Building 400 pushed the envelope by its extensive deployment of single-use technologies at commercial scale.*
- *Project Atlas was designed and delivered with the corporate philosophy in mind of being as brave as the people they help.*
- *Shire overcame numerous challenges and technical adaptations to implement fully single-use upstream process technology at a 2,000 liter scale. As a result, the facility was delivered faster with reduced investment that is also similar in size and lower in utility requirements.*

Single-use technology along with the overall design led to a facility smaller in size with diminished utility requirements and more than a quarter fewer carbon emission than a comparable stainless steel facility. While the use of cutting-edge technology makes Atlas stand out among its stainless steel contemporaries, also impressive was the execution of the project. Atlas utilized an integrated design and construction approach, integrated commissioning and validation, and a fully working mock-up of the Atlas facility's sterile train, dubbed Sandbox. Teamwork and agility were the defining characteristics for the Atlas team, and both were critical for delivering the project – ahead of schedule and under budget – amidst a remarkable series challenges introduced by market forces and opportunities.

The Atlas facility stands as an example for other life science companies who wish to increase consistency, product safety, and speed to market; decrease campaign turnover time, initial capital cost, and ongoing operation costs; and enjoy flexibility and scalability. 



Mid volume buffer tote for UF operation.

technology: media hold, inoculum preparation, seed and production bioreactors, centrifugal clarification, and harvest filtration and hold. According to Shire HGT, Atlas is the first plant to use a single-use sterile train at the 2,000 liter scale. They also employ a number of single-use technologies in downstream processing, such as buffer hold and centrifugal filtration.

To do this, they had to overcome numerous challenges and technical adaptations such as bioreactor agitation and single-use product contact surfaces in centrifuges. Shire and its project partners made a number of novel modifications to existing technology, and designed cutting-edge control software from scratch. They tackled the particularly complex problem of solution agitation in 2,000 liter single-use bioreactor bags so successfully that the bag vendor has made the team's modifications standard for all customers.

Key Project Participants

Designer/Architect: KlingStubbins (Philadelphia, Pennsylvania, USA) *(See ad on page 43)*

Engineer: Clark, Richardson, and Biskup (CRB) (Plymouth Meeting, Pennsylvania, USA) *(See ad on page 43)*

Construction Manager: Bovis Lend Lease (Boston, Massachusetts, USA) *(See ad on page 43)*



Harvest hold bag stations with iris valve.

Interview with Chaz Calitri, 2011 FOYA Judging Panel Chair



Q You have been the Facility of the Year Awards (FOYA) Judging Panel Chair for several years now and you have volunteered as a judge since the beginning of the program. What significance does the program have to you personally and why do you continue to be involved?

A First of all, it is a privilege to be a judge for ISPE's Facility of the Year Awards Program. This program is the premier recognition program for pharmaceutical engineering. I personally enjoy helping to encourage pharmaceutical companies to compete for more innovative ways to design and deliver projects that make products that help people. We work in a noble industry, in spite of the poor reputation that is portrayed in the media. As an engineering leader at a pharmaceutical company, I feel part of my responsibility is to engage across the industry to help us move pharmaceutical engineering forward. In 2007 I judged a project that won Facility of the Year. Only one year later I would learn that this facility made a new product that was used for my wife's breast cancer therapy. I would also comment that our judging panel is a team of highly skilled and experienced professionals, who are fun to work with and I learn a great deal from them and from the projects that I

review. So all in all, I love being part of this great program.

Q The judging process involves carefully reviewing each submission received and then attending a meeting with all judges present to choose the Category Winners and overall Facility of the Year Award Winner. Can you explain how the judging process works and how such difficult decisions are made in just one day?

A We have a robust process for judging that has been matured over the years. The judges are all well versed in that process. Our process has been reviewed and approved by the FOYA Committee, which oversees the entire program. We also have a continuous improvement process that we run through every year after we make our selections. As for how we can complete the process in a single day, it's simple: we spend a great deal of time preparing and we use our structured process with templates to help judge the projects. We are also calibrated as a team – the benefit of having a core group of us who have worked together for a few years. That said, we do get into open and candid debates. Judges are encouraged to challenge each other. That's how we get to the best decisions. Last year we added two judges and it was amazing how efficiently our process worked even with two new members – a testimony to our process and the caliber of professionals we have on our judging team.

Q In considering how many times a big pharma project has won the overall Facility of the Year Award and how many big pharma projects have been recognized as Category Winners, the perception might be that only big pharma companies should enter and/or can win.

Can you explain why this is not the case and can you explain why it is beneficial to small and mid size companies to enter the program?

A This program is all about innovation and helping to move our industry forward – not project or company size. Let me cite several recent examples of non-big pharma winners. Two years ago, Orchid Pharmaceuticals based in Aurrangabad, India was a Category Winner, along with Aseptic Technologies based in Gembloux, Belgium. Last year, Mann-kind Corporation (a non-profit) won TWO categories; that was an unprecedented achievement. In the 2011 program, we recently announced that Shire HGT received an Honorable Mention. So you see, it is all about engineering innovation and excellence. The reason we moved to Category Winners a few years back was to recognize projects with attributes that merit recognition, regardless of size, geography or affiliation. In fact, if you read the category definitions, you will understand what the judges are looking to reward. We also look for “capital efficiency” on projects – that is, how much was invested versus what was achieved. I can also give examples of multi-hundred million dollar investments by big pharma companies which we did not recognize as Category Winners because in our experience they spent much more money than was warranted to achieve their result. As our industry looks to contain cost, it is encouraging to see projects that are smaller in investment from companies who are innovative, and very impactful in terms of what they have achieved and contributed to our industry.

Q Based on your extensive experience as an industry professional and on your years of experience as a judge, can you describe how the Facility of the Year

"My challenge to our industry is to continue to find ways to make our products more affordable to more people. We have to enable that process. It's all about people – they are the true beneficiaries of what we do. We have to remember that always."

Awards program is truly accomplishing its goal of recognizing innovation and creativity utilized by manufacturing facilities serving the regulated health-care industry? Can you provide some examples?

A That's easy. We have created a platform to enable companies to compete in categories which we believe are crucial for successful projects. By design, this helps drive engineering teams to innovate and raise the bar. **Here is a brief recap of our categories:**

- **Process Innovation:** Application of novel process manufacturing techniques on existing and new facilities, including fundamental scientific processing approaches and related applied science-based solutions to existing and new challenges.
- **Project Execution:** Application of novel tools and approaches to delivering projects that improved efficiencies, overcame unusual challenges, promoted effectiveness, and organized stakeholders and project team participants in ways that led to successful outcomes.
- **Equipment Innovation:** Novel application of commercially available and custom developed process manufacturing and facility management tools, which yielded superior results, advanced processing understanding and improved competitive position. Includes imaginative collaboration with vendors/suppliers/manufacturers.
- **Facility Integration:** Application of good design practices and superior conceptual planning which led to excellent integration of facility and process, yielding efficient, clean, pleasant environments promoting business

advantages for staff and enterprise, encouraging excellent processing outcomes.

- **Sustainability:** Application of novel approaches, tools, and techniques intended to improve the effective use of energy, minimize waste, and reduce carbon footprints, incorporate green manufacturing techniques, reduce environmental impact, that results in more efficient processing, utilities support, and business advantage.
- **Operational Excellence:** Application of modern management techniques aimed to improve operating efficiencies, promote excellent quality, consistency and yield competitive cost of goods from existing and new facilities, processes and manufacturing operations.

Using sustainability as a case in point, only a few years ago we were asking the question as to whether sustainability even applied to pharma manufacturing. We created this category and I recall the first year we did not see any submittals that merited this category award. Since then we have seen tremendous progress in sustainable design and operations for pharma manufacturing. Our Category Winner this year not only won ISPE's award, it was also selected by its host country to represent it at the China Expo. That's impact!

Q What are some of the notable technological and innovative advances taking place in facility design and construction? How are these advances changing the way facilities are built and pharmaceuticals are produced?

A That's easy. Let me cite a few recent examples to illustrate why we believe our program is achieving innovation and

excellence. In 2010, Mannkind's project developed the first-ever solid-dosage pharmaceutical adaptation of a cryopelletizer. In 2011, Roche created a new platform for automatic drug delivery of high volume drugs to patients. A hybrid vial/cartridge was developed and named "Vartridge." The patented Vartridge has 83 individual components and requires 40 production steps to manufacture. In the area of project delivery, we have seen novel models to accelerate project delivery including hybrid models that we would not have envisioned a few years back. In Operational Excellence we have also moved the needle and had recent Category Winners that achieved huge increases in output with little added inputs. This is the case with all of our categories.

Q Do you have any advice for companies that are considering submitting an entry for the 2012 Facility of the Year Awards program?

A Don't try to impress the judges with elaborate submittals. It's all about content. Focus on WHY you feel your facility is innovative and achieved excellence that makes it a compelling story for our judges. Be specific and give us the results that were achieved.

Q Do you have any final comments about your experiences with the FOYA program?

A I love being part of this program – it's driving innovation and excellence in pharmaceutical engineering. It's helping all of us learn and grow. My challenge to our industry is to continue to find ways to make our products more affordable to more people. We have to enable that process. It's all about people – they are the true beneficiaries of what we do. We have to remember that always. 

The day Larry found himself buried in his plant's work processes.

Feel familiar?



Meeting production and regulatory demands, along with the sheer volume of manual work and data entry, can be overwhelming—keeping you from effectively optimizing your operations and slowing your plant's production. Not good—just ask Larry¹.

Syncade Smart Operations Management Suite helps you work smarter. By replacing paper-driven operations with an electronic manufacturing system, the Syncade suite increases plant-wide operational efficiency by integrating work activities with real-time information, assuring consistent production is performed right the first time. Result: Larry can now focus on what's important—increasing productivity and profitability. For more visit: www.EmersonProcess.com/Syncade.

¹Larry is a fictional character and any resemblance to you or any of your plant personnel is purely coincidental.



The Emerson logo is a trademark and a service mark of Emerson Electric Co. ©2009 Emerson Electric Company



EMERSON. CONSIDER IT SOLVED.™